

# J&S



## **Magyarország / Hungary**

---

**Horváth Miklós:**

mcex@freemail.hu

+36 30 7012963

(Budapest budai oldala, Baranya, Fejér, Győr-Sopron, Komárom, Pest m. Dunától nyugatra eső területe, Somogy, Tolna, Vas, Veszprém, Zala m.)

**Magyar Lajos:**

lajos.magyar@gmail.com

+36 30 7012964, +36 30 9270056

(Budapest pesti oldala, Bács-Kiskun, Csongrád, Heves, Nógrád, Pest m. Dunától keletre eső része, Szolnok m.)

**Vas József:**

vas.jozsef38@upcmail.hu

+36 30 7012965

(Borsod, Szabolcs, Hajdú-Bihar, Békés m.)

## **Bosznia, Horvátország, Kosovo, Macedónia, Montenegró, Szerbia, Szlovénia, / Bosnia, Croatia, Kosovo, Macedonia, Montenegro, Serbia, Slovenia**

---

**Boris Kremzar:**

boris.kremzar@siol.net

+386 41 429000

## **Románia / Romania**

---

**Aurel Oltean:**

aurel@jewe.hu

+40 723 147482

**Nicu Floroiu:**

nicu\_floroiu@yahoo.com

+40 720 959531

---

## Bemutakozás

A Jéwé Kft. Magyarország és a régió vezető barkács és lakberendezési termékeket forgalmazó nagykereskedelmi vállalkozása

Több mint 6.000 m<sup>2</sup>-es raktárunkban mintegy 2.500 különféle terméket tartunk folyamatosan készleten. Partnereink közt megtalálható Magyarország összes barkácsáruház-lánca, hipermarket láncok, valamint számos közepes és kisvállalkozás. Termékeinket több mint 10 országba exportáljuk.

Fő termékeink a CanDo® PVC bejárati ajtók, profil és négyszöglécek, Element System® fém fali polcrendszerek, Solide® kapaszkodó rendszerek, de számos egyéb termék közt megtalálhatók szortimentünkben a Barkan® készüléktartók is.

Partnereink számára legnagyobb előnyeink:

- széles választék, ezáltal időt és energiát spórolnak beszerzéskor
- raktárról, gyors szállítás, csökkenti a készletfinanszírozási költségeket, és készlethiányokat
- 1998-óta folyamatos piaci jelenlét, megbízhatóság, kiemelkedő szakmai tapasztalatok
- megbízható minőség, mert különös figyelmet fordítunk a jó minőségű termékek kiválasztása mellett a megfelelő csomagolásra, és a megfelelő fuvarozó partner kiválasztására, hogy az áru, ne csak gyorsan, de sértetlenül is érkezzen meg a címzetthez
- szolgáltatásaink, mint szaktanácsadás, bemutató állványok biztosítása, nyílászáróink szakszerű beépítéséhez országos szervízhálózat.

Cégünket 1998-ban alapította a holland tulajdonos. A Jéwé Kft 100%-ban holland tulajdonban van, és a JéwéRet céggel, a Benelux régió vezető faipari gyártójával és barkácsáru nagykereskedőjével egy csoportban, szorosan együttműködve tevékenykedünk.

## Introduction

Jéwé Kft. is one of the leading DIY and home decoration product selling wholesale companies in Hungary and in the region.

In our larger than 6.000 m<sup>2</sup> warehouse we have about 2.500 different articles continuously on stock. Among our partners you can find each DIY chain store in Hungary, hypermarket chains, and several medium size and small companies. We export our products to more than 10 countries.

Our main products are the CanDo® PVC entrance doors, wooden profiles and square moulding for DIY purposes, Element System® metal shelving system, Solide® hand rail system, but among several other articles we sell also the well-known Barkan® mounts.

The advantages if you do business with us:

- our wide range saves you time and energy in purchasing
- quick delivery from stock decreases your cost of stock financing and zero stock cases.
- continuous presence on the market since 1998 proves our reliability and professional experiences
- reliable quality of products as we pay special attention beside to the choice of quality products also to perfect packaging and to the suitable forwarder so that you get the goods not only quick but safe, without damages.
- our services like professional advisement and ensuring stands for presentation.

Jéwé Kft. was founded in 1998. The company is 100% Dutch owned, working in the same group in close cooperation with JéwéRet the leading producer and wholesaler of wood industrial products in the Benelux region.

Cégünk telephelye / Our address:

H-7673 Kővágószőlős,

Golgota hrsz. 502

GPS koordináták. É: 46°4' 59.42" ; K: 18°6' 39.46

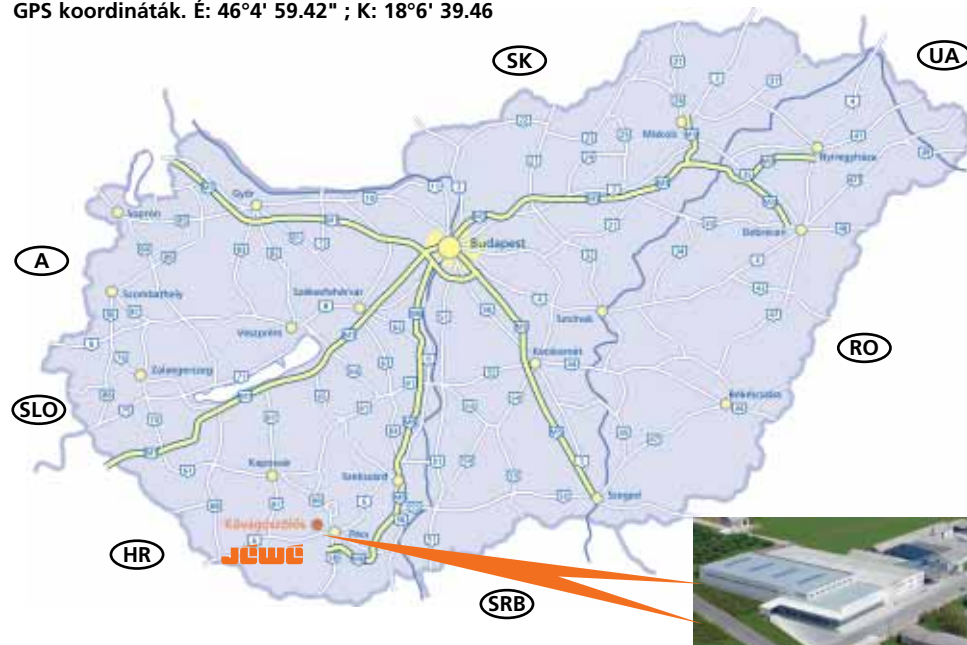

**1. Profil és négyszöglécek / Profiles and square mouldings**

- 1.01 Kör alakú profilécek / Dowels
- 1.02 Kör alakú tiplik / Fluted dowels
- 1.03 Félkör alakú profilécek / Halfround profiles
- 1.04 Negyed kör alakú profilécek / Quadrant profiles
- 1.05 Derékszögű takaróécek / Angles
- 1.06 Felső saroktakarók / Covings
- 1.07 Alsó saroktakarók / Scotias
- 1.08 Lapos tapétatakaró lécek / D-Shape covers
- 1.09 Ajtóhézag takarók / Architraves
- 1.10 Bútor díszlécek / Decorative covers
- 1.11 Takaró bútor díszlécek / Architraves
- 1.12 Íves takaróécek / Decorative covers
- 1.13 Díszítőlécek / Conca
- 1.14 Díszítő saroklécek / Hockeysticks
- 1.15 Háromszögű lécek / Triangles
- 1.16 Üvegező lécek / Glass beads
- 1.17 Képkeret lécek / Picture frames
- 1.18 CanDo® fóliázott padlószegélyek / CanDo® foil wrapped skirting
- 1.19 Négyszögletes gyalult lécek – I / Planed stripwood – I
- 1.20 Négyszögletes gyalult lécek – II / Planed stripwood – II
- 1.21 Négyszögletes fűrészelt lécek / Sawn stripwood
- 1.22 Darabolt lécek / Short mouldings
- 1.23 Balza hobby lécek / Balsa hobby slats
- 1.24 Alumínium és PVC profilok / Aluminium and PVC profiles

**2. Fém fali polcrendszerek (E.S.) / Metal shelving system**

- 2.01 Egysoros falsínes rendszer / One slot rail system
- 2.02 Duplasoros falsínes rendszer / Double slot rail system
- 2.03 Szögkonzol 2 horgas / Angle bracket with 2 claws
- 2.04 Csőtartó konzol / Tube holder bracket
- 2.05 Kiegészítő alkatrészek / Accessories
- 2.06 Fémkonzolok, polctartók / Metal brackets

2.07 Szerszámfal rendszer / Workshop organizer system

2.08 Fém asztallábak / Steel table legs

**3. Polclapok, polcszettek, polctartók / Shelves and brackets**

- 3.01 Laminált polclapok / Laminated shelves
- 3.02 Laminált polcpanelek / Laminated boards
- 3.03 Laminált sarokpolcok / Laminated corner-shelves
- 3.04 Élfóliák / Side-foils
- 3.05 Regalo polcok / Regalo shelves
- 3.06 Lebegőpolcok / Floating shelves
- 3.07 Létrapolc szettek / Scale bracket set
- 3.08 Tömörfenyő polclapok / Pine glue lam panels
- 3.09 Telefon- és sarokpolcok / Telephone and corner-shelves
- 3.10 Polc szettek / Small kit shelves
- 3.11 Fakonzolok / Wooden brackets
- 3.12 Aqua® üvegpolcok / Aqua® glass-shelves
- 3.13 Polc és üvegpolc tartók / Shelf and glass-shelf brackets

**4. Kisbútorok, álló polcok / Kit furniture**

- 4.01 Fadobozok és előszoba tartozékok / Wooden boxes and hall accessories
- 4.02 Ülőkék / Stools
- 4.03 Háztartási polcok / Household racks
- 4.04 Acélpolcok / metal racks
- 4.05 Zsalus ajtók / Louvre doors

**5. Barkan fali TV-tartók és egyéb készüléktartók / Barkan wall mounts**

- 5.01 LCD TV tartók / LCD TV wall mounts
- 5.02 Egyéb készüléktartók / Other wall mounts
- 5.03 Univerzális telefon és GPS tartó / Universal car mount
- 5.04 Tablettartó / Universal mount

**6. Egyéb termékek / Other products**

- 6.01 Fa kerítés elemek / Wooden fence elements
- 6.02 Fa korlátelelemek / Wooden baluster elements
- 6.03 Solide® kapaszkodó rendszer / Solide® handrail system
- 6.04 Küszöbök és lépcsőlapok / Door-steps and stair parts
- 6.05 Boros polcok, palacktartó rendszerek / Wine racks
- 6.06 HKC teraszdudlók / HKC garden decking
- 6.07 Ruhaszárító / Clothes dryer rack
- 6.08 Védőrácsok / Stairgates
- 6.09 Egyéb termékek / Other products
- 6.10 Alkohol desztilláló készülékek / Alcohol distillers

**7. Nyílászárók / Doors and windows**

- 7.01 PVC mellékbejárati ajtók / PVC side-doors
- 7.02 CanDo® bejárati ajtók / CanDo® front doors
- 7.03 PVC ablakok / PVC windows
- 7.04 Kiegészítő termékek / Optional accessories
- 7.05 Ablakkönyöklők / Windowsills
- 7.06 CanDo® beltéri ajtók / CanDo® interior doors
- 7.07 Stoppajtó-ablak kitámasztó / door and windowstopper

# JÉWE

1

**PROFIL- ÉS NÉGYSZÖGLÉCEK**  
**PROFILE AND SQUARE MOULDINGS**



## Termékcsoport / Product range

### 1.01



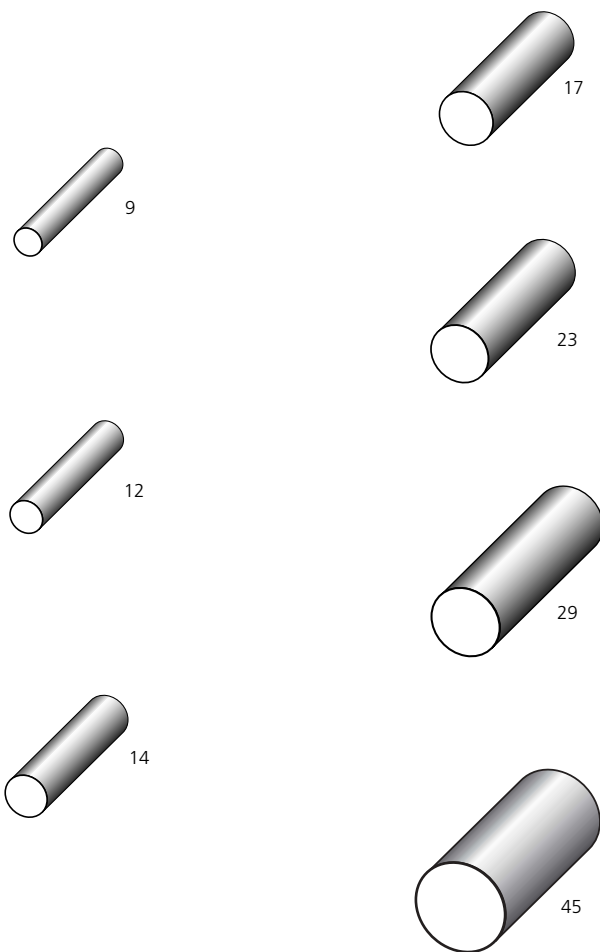













#### Kör alakú profilécek Dowels



JÉWÉ megnevezés JÉWÉ product name	Alapanyag Material	Méret (mm) Size (mm)	Megrendelési egység Order unit	EAN kód EAN code	JÉWÉ kód JÉWÉ code 240 cm
RO 9 M	Marupa	Ø 9	36	8711283234113	<b>1401001</b>
RO 12 M	Marupa	Ø 12	28	8711283234212	<b>1401006</b>
RO 14 M	Marupa	Ø 14	24	8711283234311	<b>1401011</b>
RO 18 M	Marupa	Ø 17	20	8711283234410	<b>1401016</b>
RO 23 M	Marupa	Ø 23	12	8711283234519	<b>1401021</b>
RO 29 M	Marupa	Ø 28	9	8711283234717	<b>1401026</b>
RO 9 GRT	Erdei fenyő/Pine	Ø 9	36	8711283157115	<b>1401036</b>
RO 14 GRT	Erdei fenyő/Pine	Ø 14	24	8711283157818	<b>1401041</b>
RO 23 GRT	Erdei fenyő/Pine	Ø 22	12	8711283158013	<b>1401046</b>
RO 29 GRT	Erdei fenyő/Pine	Ø 28	9	8711283158112	<b>1401051</b>
RO 45 GRT	Erdei fenyő/Pine	Ø 45	2	8711283101422	<b>1401062</b>

270 cm

## Termékcsoport / Product range

	JÉWÉ megnevezés JÉWÉ product name	Alapanyag Material	Méret (mm) Size (mm)	Megrendelési egység Order unit	EAN kód EAN code	JÉWÉ kód JÉWÉ code 100 cm
<b>1.01</b>						
<b>Kör alakú profillécek Dowels</b>						
 4	RO 4 B	áBükk/Beech	Ø 4	50	8711283097282	<b>1401079</b>
 6	RO 6 B	Bükk/Beech	Ø 6	50	8711283014272	<b>1401080</b>
 8	RO 8 B	Bükk/Beech	Ø 8	50	8711283014289	<b>1401081</b>
 10	RO 10 B	Bükk/Beech	Ø 10	50	8711283014296	<b>1401082</b>
 12	RO 12 B	Bükk/Beech	Ø 12	25	8711283014302	<b>1401083</b>
 15	RO 15 B	Bükk/Beech	Ø 15	12	8711283014319	<b>1401084</b>
 17	RO 18 B	Bükk/Beech	Ø 17	12	8711283014326	<b>1401085</b>
 22	RO 22 B	Bükk/Beech	Ø 22	12	8711283014333	<b>1401086</b>
 30	RO 30 B	Bükk/Beech	Ø 30	6	8711283075822	<b>1401088</b>
 36	RO 36 B	Bükk/Beech	Ø 36	6	8711283323183	<b>1401089</b>
<b>1.02</b>						
<b>Kör alakú tiplik / Fluted dowels</b>						
 6	BG 6 B	Bükk/Beech	Ø 6	50	8711283014210	<b>1401110</b>
 8	BG 8 B	Bükk/Beech	Ø 8	50	8711283014227	<b>1401111</b>
 10	BG 10 B	Bükk/Beech	Ø 10	50	8711283014234	<b>1401112</b>
 12	BG 12 B	Bükk/Beech	Ø 12	50	8711283014241	<b>1401113</b>
 15	BG 15 B	Bükk/Beech	Ø 15	25	8711283014258	<b>1401114</b>
 18	BG 18 B	Bükk/Beech	Ø 18	25	8711283014265	<b>1401115</b>

## Termékcsoport / Product range

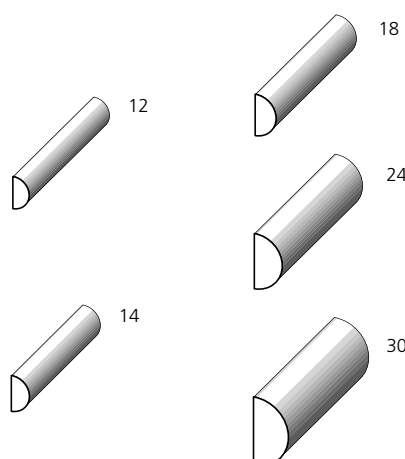
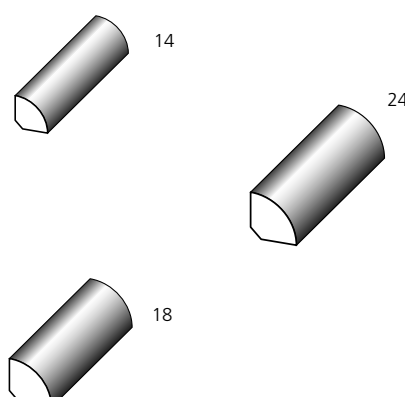
Termékcsoport / Product range	JÉWÉ megnevezés JÉWÉ product name	Alapanyag Material	Méret (mm) Size (mm)	Megrendelési egység Order unit	EAN kód EAN code	JÉWÉ kód JÉWÉ code		
						210 cm	240 cm	
<b>1.03</b> <b>Félkör alakú profilécek</b> <b>Halfround</b> 	HR 12 GRT	Erdei fenyő/Pine	4 x 11	21	8711283167411		<b>1404001</b>	
	HR 18 GRT	Erdei fenyő/Pine	7 x 18	20	8711283167510		<b>1404010</b>	
	HR 24 GRT	Erdei fenyő/Pine	9 x 22	16	8711283167619		<b>1404013</b>	
	HR 30 GRT	Erdei fenyő/Pine	12 x 29	12	8711283167701	<b>1404015</b>		
	HR 12 M	Marupa	4 x 11	21	8711283208619		<b>1404000</b>	
	HR 14 M	Marupa	5 x 13	24	8711283208718		<b>1404004</b>	
	HR 18 M	Marupa	7 x 18	20	8711283231914		<b>1404007</b>	
	<b>1.04</b> <b>Negyedkör alakú profilécek</b> <b>Quadrant</b> 	KW 14 GR	Erdei fenyő/Pine	13 x 13	24	8711283117614		<b>1404034</b>
		KW 18 GR	Erdei fenyő/Pine	16 x 16	20	8711283123110		<b>1404040</b>
		KW 24 GR	Erdei fenyő/Pine	22 x 22	18	5996025060196		<b>1404045</b>
KW 18 M		Marupa	17 x 17	20	8711283208817		<b>1404041</b>	
KW 24 M		Marupa	22 x 22	12	8711283232119		<b>1404047</b>	



## Termékcsoport / Product range

1.05

### Derékszögű takarólécek Angles

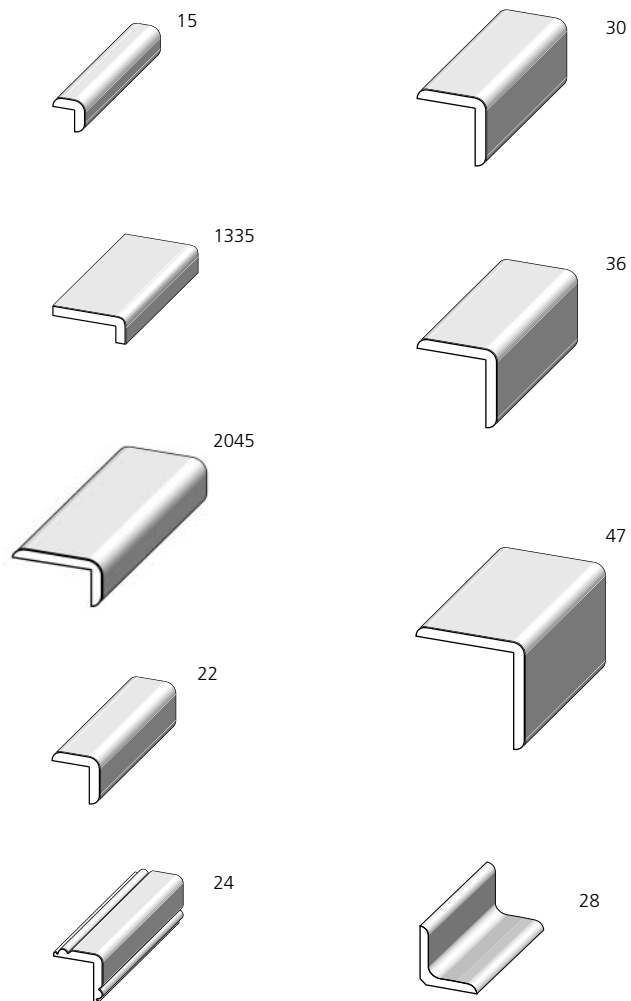

JÉWÉ megnevezés JÉWÉ product name	Alapanyag Material	Méret (mm) Size (mm)	Megrendelési egység Order unit	EAN kód EAN code	JÉWÉ kód JÉWÉ code 240 cm
H 15 CP	Erdei fenyő Pine	13 x 13	16	8711283156910	<b>1402001</b>
H 22 CP	Erdei fenyő Pine	20 x 20	16	8711283103716	<b>1402013</b>
H 30 CP	Erdei fenyő Pine	27 x 27	16	8711283103815	<b>1402022</b>
H 36 CP	Erdei fenyő Pine	34 x 34	16	8711283103914	<b>1402031</b>
H 47 GR	Erdei fenyő Pine	45 x 45	12	8711283181714	<b>1402037</b>
H 1335 GR	Erdei fenyő Pine	12 x 32	16	8711283158310	<b>1402007</b>
H 2045 GRT	Erdei fenyő Pine	20 x 44	12	5996025060189	<b>1402009</b>
H 15 M	Marupa	13 x 13	16	8711283228600	<b>1402004</b>
H 22 M	Marupa	20 x 20	16	8711283228501	<b>1402016</b>
H 24 M	Marupa	21 x 21	16	8711283230511	<b>1402019</b>
HB 28 M	Marupa	27 x 27	16	8711283230115	<b>1402041</b>
H 30 M	Marupa	27 x 27	16	8711283228402	<b>1402025</b>
H 30 HHR	Vörös keményfa Red hardwood	27 x 27	16	8711283103310	<b>1402028</b>
H 36 HHR	Vörös keményfa Red hardwood	34 x 34	16	8711283103419	<b>1402036</b>

## Termékcsoport / Product range

### 1.06

#### Felső saroktakarók Coving

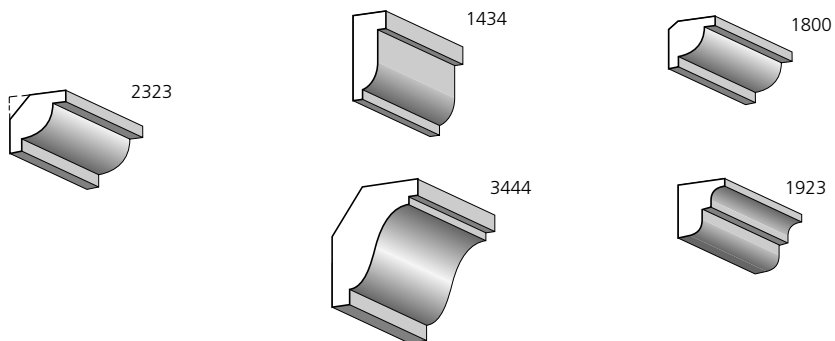

JÉWÉ megnevezés JÉWÉ product name	Alapanyag Material	Méret (mm) Size (mm)	Megrendelési egység Order unit	EAN kód EAN code	JÉWÉ kód JÉWÉ code 240 cm
PL 1434 GR	Erdei fenyő/Pine	13 x 34	12	8711283165813	<b>1404084</b>
PL 1800 GR	Erdei fenyő/Pine	16 x 16	24	8711283116617	<b>1404093</b>
PL 2323 KFR	Erdei fenyő/Pine	22 x 22	18	8711283122816	<b>1404105</b>
PL 3444 GRN	Erdei fenyő/Pine	33 x 44	8	8711283116419	<b>1404119</b>
PL 1923 V	Erdei fenyő/Pine	18 x 18	24	8711283116310	<b>1404096</b>

### 1.07

#### Alsó saroktakarók Scotia

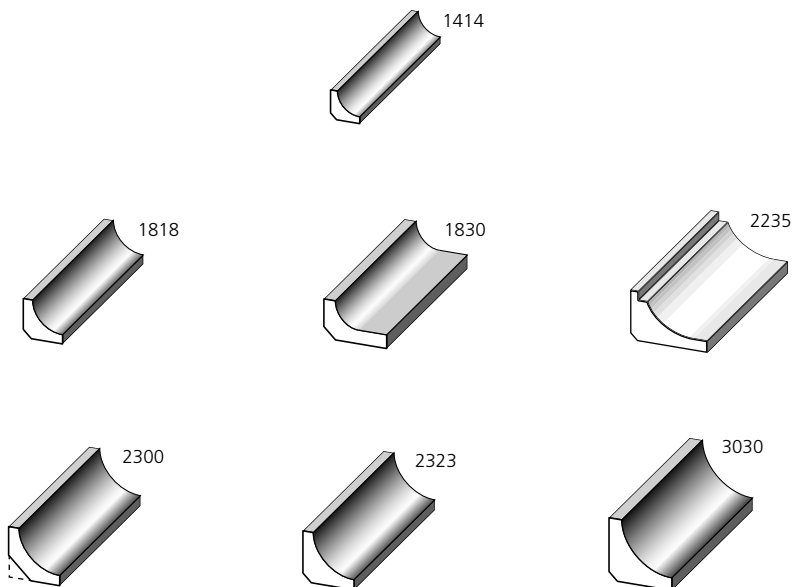

HOL 1414 GR	Erdei fenyő/Pine	13 x 13	25	8711283125015	<b>1404141</b>
HOL 1818 GR	Erdei fenyő/Pine	16 x 16	24	8711283124018	<b>1404153</b>
HOL 1830 KFR	Erdei fenyő/Pine	18 x 28	18	8711283124117	<b>1404162</b>
HOL 2235 GR	Erdei fenyő/Pine	22 x 33	12	8711283112619	<b>1404166</b>
HOL 2323 GR	Erdei fenyő/Pine	23 x 23	18	8711283124216	<b>1404175</b>
HOL 3030 GR	Erdei fenyő/Pine	28 x 28	12	8711283124315	<b>1404181</b>
HOL 2300 M	Marupa	22 x 22	18	8711283200316	<b>1404172</b>
HOL 2235 M	Marupa	22 x 34	12	8711283209012	<b>1404169</b>

## Termékcsoport / Product range

### 1.08

#### Lapos tapétatakaró lécek Cover D-shape

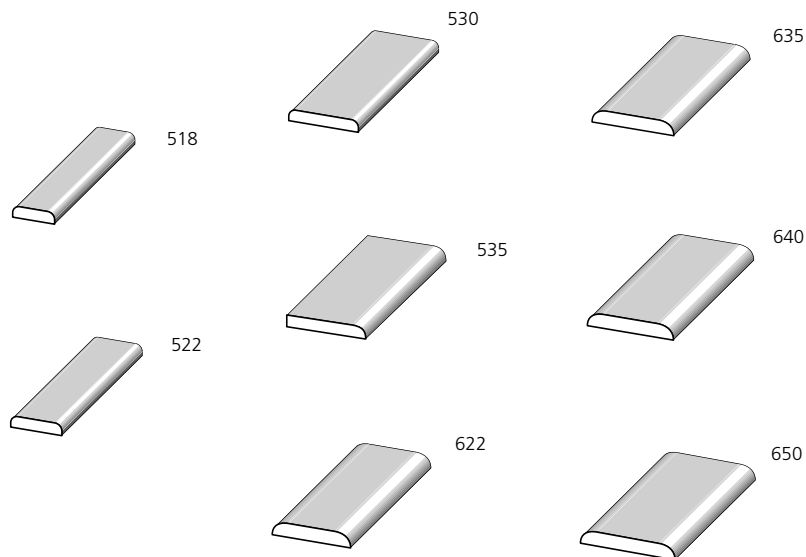

JÉWÉ megnevezés JÉWÉ product name	Alapanyag Material	Méret (mm) Size (mm)	Megrendelési egység Order unit	EAN kód EAN code	JÉWÉ kód JÉWÉ code 240 cm
DL 518 GR	Erdei fenyő/Pine	4 x 18	24	8711283160214	<b>1404201</b>
DL 522 GR	Erdei fenyő/Pine	4 x 22	24	8711283109619	<b>1404213</b>
DL 530 GR	Erdei fenyő/Pine	4 x 30	24	8711283109718	<b>1404222</b>
DL 535 GR	Erdei fenyő/Pine	5 x 33	24	8711283182018	<b>1404234</b>
DL 622 GR	Erdei fenyő/Pine	6 x 22	24	8711283160313	<b>1404237</b>
DL 640 GR	Erdei fenyő/Pine	6 x 37	15	8711283157313	<b>1404240</b>
DL 522 M	Marupa	4 x 22	24	8711283200019	<b>1404216</b>
DL 530 M	Marupa	4 x 30	24	8711283202310	<b>1404225</b>
DL 622 M	Marupa	6 x 22	24	8711283204116	<b>1404236</b>
DL 635 M	Marupa	6 x 35	24	8711283208411	<b>1404239</b>
DL 650 M	Marupa	6 x 45	24	8711283231310	<b>1404246</b>
DL 530 HHR	Vörös keményfa Red hardwood	4 x 30	24	8711283188010	<b>1404228</b>





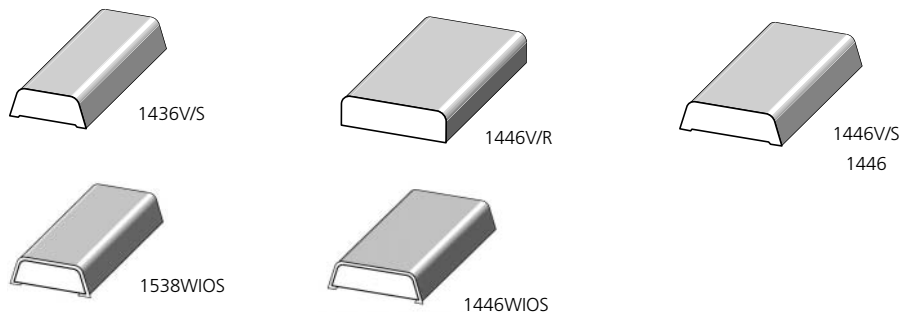

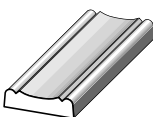
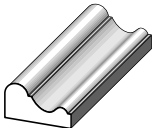

### 1.09

#### Ajtóhézag takaró lécek Architrave

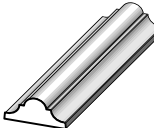

KO 1436 V/S	Erdei fenyő Pine	12 x 34	18	8711283118925	<b>1404271</b>
KO 1446 V/R	Erdei fenyő Pine	12 x 45	12	8711283118727	<b>1404274</b>
KO 1446 V/S	Erdei fenyő Pine	12 x 45	12	8711283118826	<b>1404277</b>
KO 1538 WIOS	Fehér MDF fóliázott White MDF foiled	12 x 37	8	8711283362274	<b>1404287</b>
KO 1446 WIOS	Fehér MDF White MDF	12 x 45	8	8711283362281	<b>1404291</b>

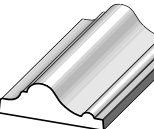
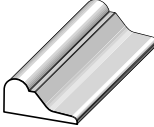
## Termékcsoport / Product range

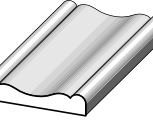
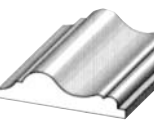
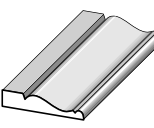
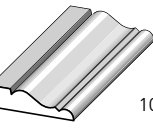
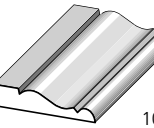
1.10		JÉWÉ megnevezés JÉWÉ product name	Alapanyag Material	Méret (mm) Size (mm)	Megrendelési egység Order unit	EAN kód EAN code	JÉWÉ kód JÉWÉ code 240 cm
<b>Bútordíszlécek Decorative cover</b>							
	510	BA 831 GRT	Erdei fenyő/Pine	8 x 30	12	8711283157214	<b>1404326</b>
	831	BA 922 KFR	Erdei fenyő/Pine	9 x 22	32	8711283151717	<b>1404329</b>
	1629	BA 1022 GRT	Erdei fenyő/Pine	9 x 22	24	8711283166919	<b>1404336</b>
	1050	BA 1050 GR	Erdei fenyő/Pine	8 x 45	12	8711283159515	<b>1404345</b>
	1629	BA 1629 GRT	Erdei fenyő/Pine	16 x 32	12	8711283152011	<b>1404360</b>
	1633	BA 1633 GRT	Erdei fenyő/Pine	33 x 16	24	8711283152318	<b>1404362</b>
	714	BA 1645 GRT	Erdei fenyő/Pine	16 x 45	8	8711283152110	<b>1404363</b>
	922	BA 1868 GRT	Erdei fenyő/Pine	68 x 18	8	8711283152714	<b>1404369</b>
	722	BA 714 M	Marupa	6 x 14	24	8711283202211	<b>1404317</b>
	1022	BA 722 M	Marupa	6 x 22	24	8711283199818	<b>1404320</b>
	1645	BA 724 M	Marupa	6 x 22	24	8711283207315	<b>1404323</b>
	1735	BA 1022 M	Marupa	9 x 22	24	8711283199917	<b>1404339</b>
	724	BA 1735 M	Marupa	17 x 35	12	8711283208015	<b>1404368</b>
	1050	BA 510 HHR	Vörös keményfa Red hardwood	4 x 10	40	8711283106618	<b>1404311</b>
	1868	BA 1022 HHR	Vörös keményfa Red hardwood	9 x 22	24	8711283151113	<b>1404342</b>
<b>1.11</b>							
<b>Takaró bútordíszlécek Architrave</b>							
	835	CH 835 M	Marupa	8 x 33	12	8711283250519	<b>1404391</b>
	1040	CH 1040 M	Marupa	9 x 36	12	8711283250618	<b>1404394</b>
	1050	CH 1050 M	Marupa	8 x 45	12	8711283250717	<b>1404397</b>

## Termékcsoport / Product range

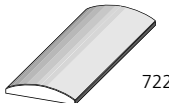
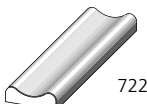
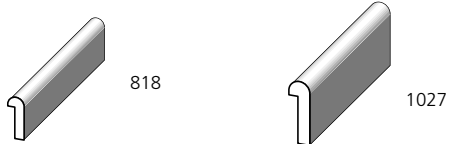
Termékcsoport / Product range	JÉWÉ megnevezés JÉWÉ product name	Alapanyag Material	Méret (mm) Size (mm)	Megrendelési egység Order unit	EAN kód EAN code	JÉWÉ kód JÉWÉ code	
						210 cm	240 cm
<b>1.12</b> Íves takarólécek Halfoval 	HO 722 GR	Erdei fenyő/Pine	6 x 22	24	8711283167305	<b>1404410</b>	
<b>1.13</b> Díszítőlécek Concave 	GO 722 GRT GO 722 M	Erdei fenyő/Pine Marupa	6 x 22 6 x 22	24 24	8711283167107 8711283231518	<b>1404433</b>	<b>1404436</b>
<b>1.14</b> Díszítő saroklécek Hockeystick 	HS 818 GRT HS 1027 GR HS 1027 M HS 818 HHR	Erdei fenyő/Pine Erdei fenyő/Pine Marupa Vörös keményfa Red hardwood	7 x 18 9 x 27 9 x 27 7 x 18	24 24 24 24	8711283161617 8711283160115 8711283200217 8711283120515	<b>1404451</b> <b>1404457</b>	<b>1404460</b> <b>1404454</b>

## Termékcsoport / Product range

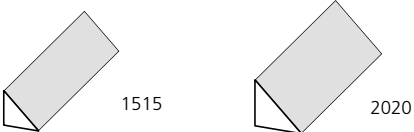
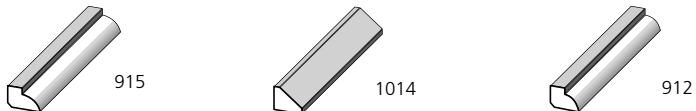
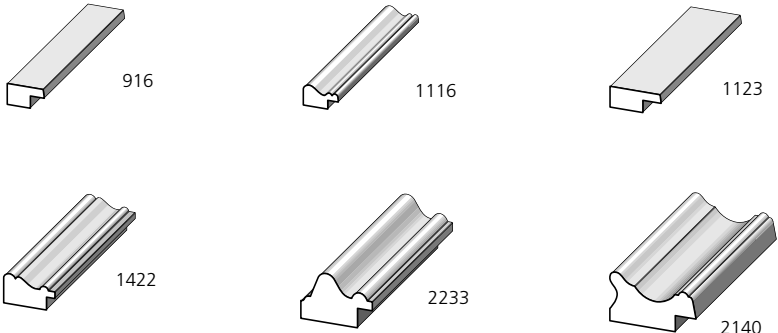
Termékcsoport / Product range	JÉWÉ megnevezés JÉWÉ product name	Alapanyag Material	Méret (mm) Size (mm)	Megrendelési egység Order unit	EAN kód EAN code	JÉWÉ kód JÉWÉ code	
						210 cm	240 cm
<b>1.15</b> <b>Háromszögű lécek</b> <b>Triangle</b> 	DR 1515 V	Lucfenyő Whitewood	15 x 15	24	8711283122205	<b>1404480</b>	
	DR 2020 V	Lucfenyő Whitewood	20 x 20	24	8711283122304	<b>1404483</b>	
<b>1.16</b> <b>Üvegező lécek</b> <b>Glass beads</b> 	GL 915 GR	Erdei fenyő/Pine	9 x 15	25	8711283153513		<b>1404504</b>
	GL 1014 GR	Erdei fenyő/Pine	9 x 13	24	8711283160412		<b>1404507</b>
	GL 912 HHR	Vörös keményfa Red hardwood	9 x 12	36	8711283115610		<b>1404501</b>
<b>1.17</b> <b>Képkeret lécek</b> <b>Picture frame</b> 	ST 916 GR	Erdei fenyő/Pine	9 x 15	18	8711283166209	<b>1403001</b>	
	ST 1116 GR	Erdei fenyő/Pine	9 x 15	18	8711283158501	<b>1403011</b>	
	ST 1123 GR	Erdei fenyő/Pine	9 x 21	18	8711283166308	<b>1403017</b>	
	ST 1422 GR	Erdei fenyő/Pine	12 x 21	18	8711283158600	<b>1403023</b>	
	ST 2140 GR	Erdei fenyő/Pine	21 x 36	8	8711283158709	<b>1403029</b>	
	ST 2233 GR	Erdei fenyő/Pine	21 x 33	12	8711283181806	<b>1403035</b>	

## Termékcsoport / Product range

1.18

CanDo® fehér fóliázott padlószegélyek  
CanDo® white foil wrapped skirting

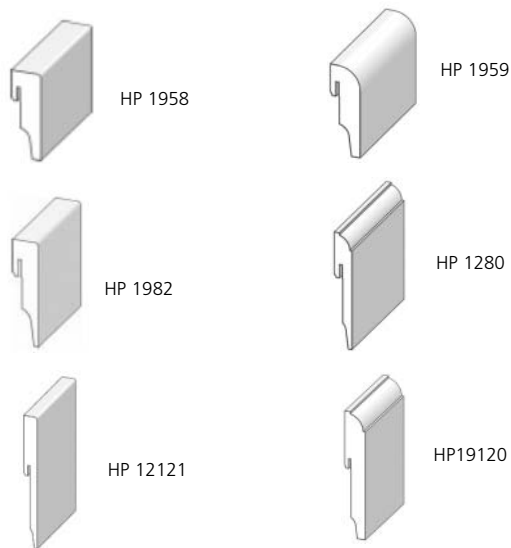

Termékcsoport / Product range	JÉWÉ megnevezés JÉWÉ product name	Alapanyag Material	Méret (mm) Size (mm)	Megrendelési egység Order unit	EAN kód EAN code	JÉWÉ kód JÉWÉ code 255 cm	
<p>CanDo® fehér fóliázott padlószegélyek CanDo® white foil wrapped skirting</p>	HP 1958	MDF fóliázva Foiled MDF	19 x 58	6	8711283344300	<b>1406100</b>	
	HP 1959	MDF fóliázva Foiled MDF	19 x 59	6	8711283344324	<b>1406104</b>	
	HP 1982	MDF fóliázva Foiled MDF	19 x 82	6	8711283362915	<b>1406102</b>	
	HP 1280	MDF fóliázva Foiled MDF	12 x 80	6	8711283344362	<b>1406103</b>	
	HP 12121	MDF fóliázva Foiled MDF	12 x 121	4	8711283344317	<b>1406105</b>	
	HP 19120	MDF fóliázva Foiled MDF	19 x 120	4	8711283344393	<b>1406106</b>	
		Rögzítő klipsz 25 db CanDo fixing clips			12	8711283384696	<b>1406160</b>
		Belső sarok 2 db CanDo internal corner		25 x 25 x 123	6	8711283366043	<b>1406161</b>
		Külső sarok 2 db CanDo external corner		25 x 25 x 123	6	8711283366050	<b>1406162</b>
		Végzáró 2 db CanDo endcap		25 x 4 x 123	6	8711283377131	<b>1406163</b>
		A kiegészítők bliszterben csomagolva Accessories are packed in blister					

## Termékcsoport / Product range

1.19

Négyszögletes gyalult lécek - I  
Planed stripwood - I

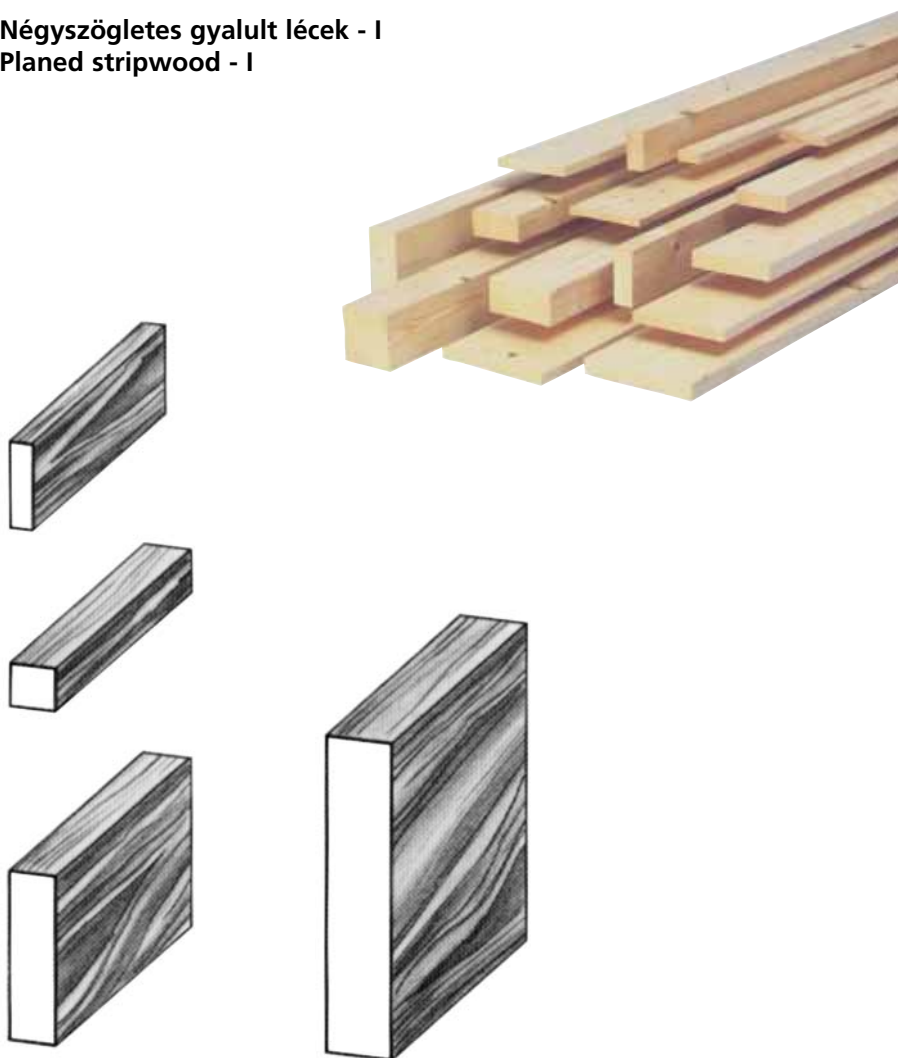

JÉWÉ megnevezés JÉWÉ product name	Alapanyag Material	Méret (mm) Size (mm)	Megrendelési egység Order unit	EAN kód EAN code	JÉWÉ kód JÉWÉ code 240 cm
SL 7 x 7	Fenyő Pine	7 x 7	48	8711283131023	<b>1503001</b>
SL 7 x 18		7 x 18	48	8711283131122	<b>1503004</b>
SL 7 x 27		7 x 27	36	8711283126128	<b>1503007</b>
SL 7 x 36		7 x 36	36	8711283126227	<b>1503010</b>
SL 7 x 44		7 x 44	24	8711283126326	<b>1503013</b>
SL 7 x 56		7 x 56	24	8711283126425	<b>1503016</b>
SL 12,5 x 12,5		12,5 x 12,5	42	8711283126623	<b>1503031</b>
SL 12 x 18		12 x 18	24	8711283126722	<b>1503034</b>
SL 12 x 27		12 x 27	21	8711283126821	<b>1503037</b>
SL 12 x 36		12 x 36	21	8711283126920	<b>1503040</b>
SL 12 x 44		12 x 44	14	8711283127026	<b>1503043</b>
SL 12 x 56		12 x 56	14	8711283125329	<b>1503046</b>
SL 12 x 69		12 x 69	7	8711283127224	<b>1503049</b>
SL 12 x 92		12 x 92	7	8711283127323	<b>1503052</b>
SL 14 x 28		14 x 28	21	5996025060653	<b>1503060</b>
SL 14 x 48		14 x 48	14	5996025060660	<b>1503062</b>
SL 14 x 70		14 x 70	14	5996025060677	<b>1503064</b>
SL 14 x 95		14 x 95	7	5996025060684	<b>1503066</b>
SL 14 x 120		14 x 120	7	5996025060691	<b>1503068</b>



## Termékcsoport / Product range

1.20

Négyszögletes gyalult lécek - II  
Planed stripwood - II

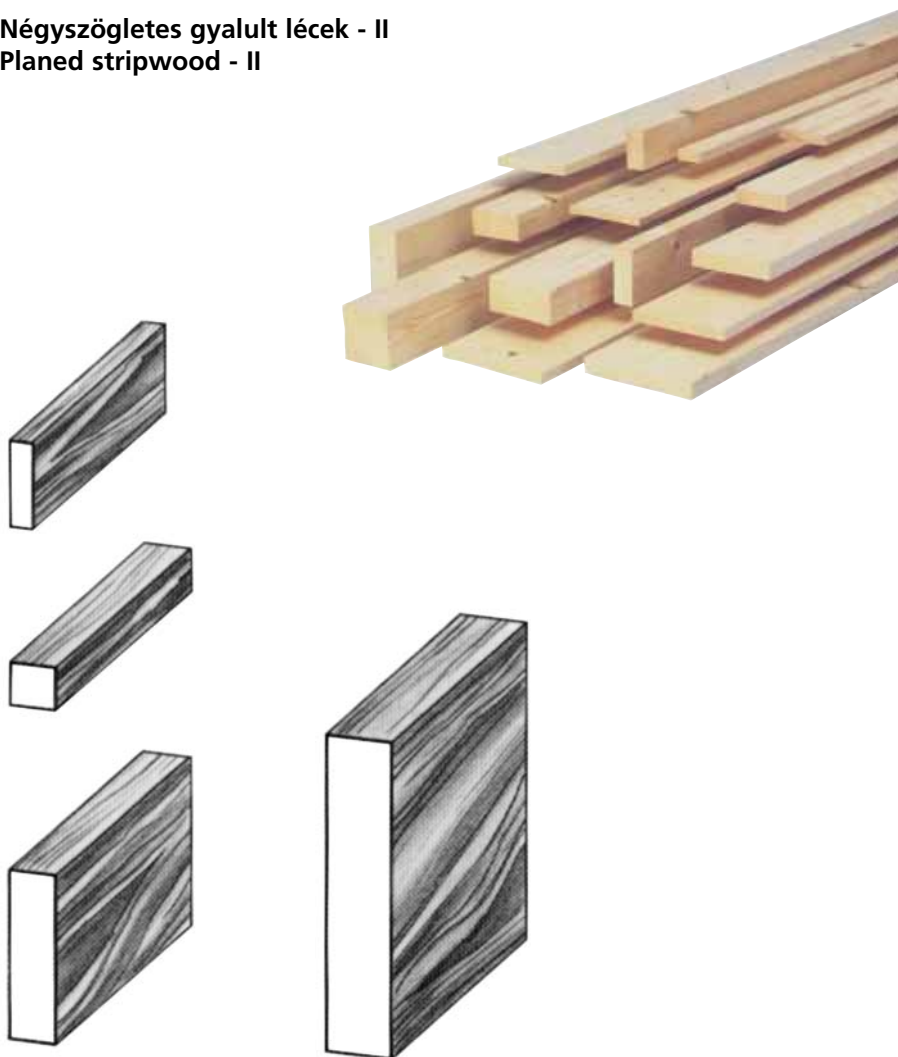

JÉWÉ megnevezés JÉWÉ product name	Alapanyag Material	Méret (mm) Size (mm)	Megrendelési egység Order unit	EAN kód EAN code	JÉWÉ kód JÉWÉ code 240 cm
SL 18 x 18	Fenyő Pine	18 x 18	20	8711283127620	<b>1503071</b>
SL 18 x 28		18 x 28	15	8711283127729	<b>1503074</b>
SL 18 x 36		18 x 36	15	8711283161822	<b>1503077</b>
SL 18 x 44		18 x 44	10	8711283125428	<b>1503080</b>
SL 18 x 56		18 x 56	10	8711283198927	<b>1503082</b>
SL 18 x 69		18 x 69	5	8711283125527	<b>1503085</b>
SL 18 x 92		18 x 92	5	8711283125626	<b>1503088</b>
SL 28 x 28		28 x 28	12	8711283125824	<b>1503101</b>
SL 28 x 38		28 x 38	9	5996025060707	<b>1503102</b>
SL 27 x 44		27 x 44	6	8711283125923	<b>1503107</b>
SL 28 x 48		28 x 48	6	5996025060714	<b>1503108</b>
SL 28 x 60		28 x 60	6	5996025060721	<b>1503111</b>
SL 28 x 93		28 x 93	5	8711283129327	<b>1503116</b>
SL 28 x 120		28 x 120	1	5996025060738	<b>1503118</b>
SL 34 x 34		34 x 34	9	8711283131825	<b>1503131</b>
SL 34 x 56		34 x 56	6	8711283131924	<b>1503137</b>
SL 44 x 44		44 x 44	4	8711283131528	<b>1503150</b>

## Termékcsoport / Product range

1.21

Négyzetletes fűrészelt lécek  
Sawn stripwood

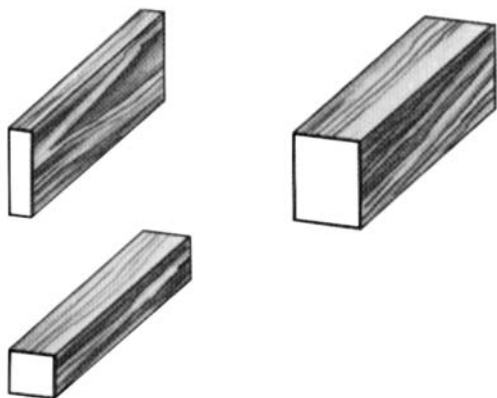

JÉWÉ megnevezés JÉWÉ product name	Alapanyag Material	Méret (mm) Size (mm)	Megrendelési egység Order unit	EAN kód EAN code	JÉWÉ kód JÉWÉ code 220 cm
BF 12x30	Fenyő Spruce	12 x 30	36	5996025048606	<b>1501010</b>
BF 12x50		12 x 45	24	5996025048613	<b>1501015</b>
BF 12x90		12 x 90	12	5996025048620	<b>1501020</b>
BF 18x30		18 x 30	21	5996025048637	<b>1501025</b>
BF 18x50		18 x 50	14	5996025048644	<b>1501030</b>
BF 18x70		18 x 70	14	5996025048651	<b>1501035</b>
BF 24x24		22 x 22	20	5996025048668	<b>1501040</b>
BF 24x30		24 x 30	15	5996025048675	<b>1501045</b>
BF 24x40		24 x 45	15	5996025048682	<b>1501050</b>
BF 24x50		24 x 50	10	5996025048699	<b>1501055</b>
BF 30x30		30 x 30	12	5996025048705	<b>1501060</b>
BF 30x40		30 x 40	9	5996025048712	<b>1501065</b>
BF 30x45		30 x 45	6	5996025048729	<b>1501070</b>
BF 30x50		30 x 50	6	5996025048736	<b>1501075</b>
BF 30x60		30 x 60	6	5996025048743	<b>1501080</b>
BF 50x50		45 x 45	4	5996025048774	<b>1501095</b>
BF 50x70		45 x 69	1	5996025048781	<b>1501100</b>
<b>200 cm</b>					
Párnafa Wooden bolster		18 x 34	15	5996025057998	<b>1501200</b>
<b>300 cm</b>					
Párnafa Wooden bolster		18 x 34	15	5996025059497	<b>1501201</b>

## Termékcsoport / Product range

### 1.22

#### Darabolt lécek Small length mouldings

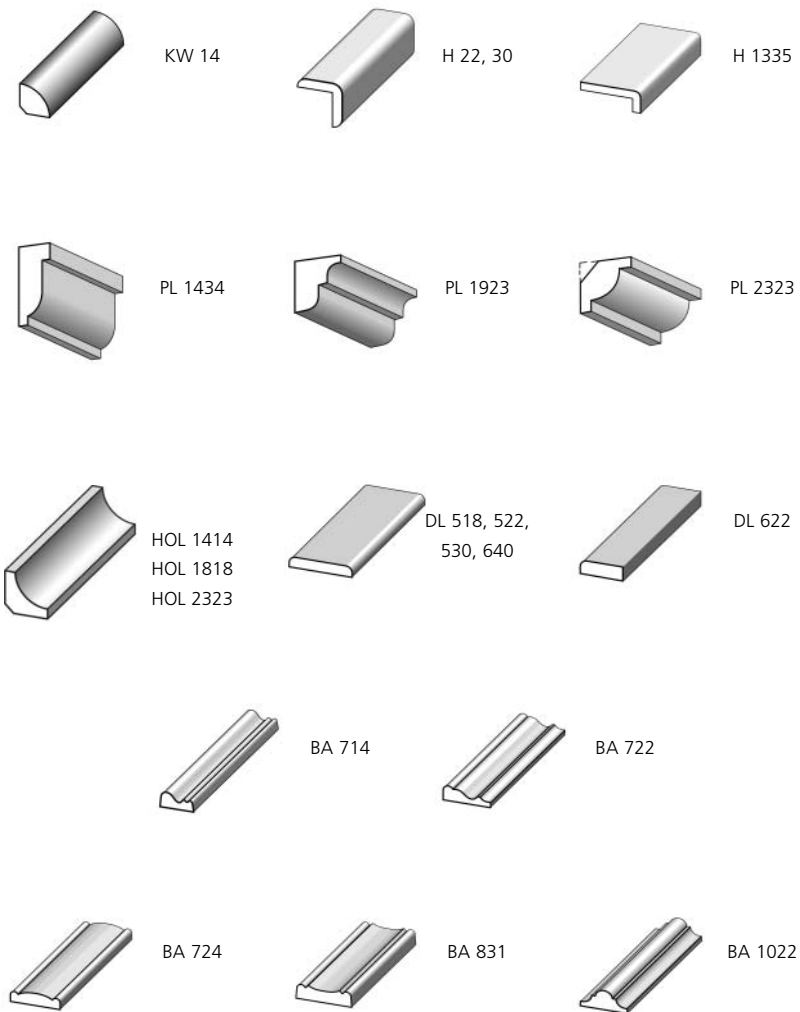

JÉWÉ megnevezés JÉWÉ product name	Alapanyag Material	Méret (mm) Size (mm)	Megrendelési egység Order unit	EAN kód EAN code	JÉWÉ kód JÉWÉ code 120 cm
KW 14 GR	Erdei fenyő/Pine	13 x 13	40	5996025046695	<b>1408000</b>
H 22 CP	Carolina fenyő/Carolina pine	20 x 20	32	5996025046602	<b>1408010</b>
H 30 CP	Carolina fenyő/Carolina pine	27 x 27	32	5996025046596	<b>1408011</b>
H 1335 GR	Erdei fenyő/Pine	12 x 32	32	5996025046589	<b>1408012</b>
PL 1434 GR	Erdei fenyő/Pine	13 x 34	36	5996025052931	<b>1408030</b>
PL 1923 V	Erdei fenyő/Pine	18 x 18	48	5996025046688	<b>1408031</b>
PL 2323 KFR	Erdei fenyő/Pine	22 x 22	36	5996025046749	<b>1408032</b>
HOL 1414 GR	Erdei fenyő/Pine	13 x 13	50	5996025046770	<b>1408050</b>
HOL 1818 GR	Erdei fenyő/Pine	16 x 16	48	5996025046756	<b>1408051</b>
HOL 2323 GR	Erdei fenyő/Pine	23 x 23	36	5996025046763	<b>1408052</b>
DL 518 GR	Erdei fenyő/Pine	4 x 18	48	5996025046800	<b>1408070</b>
DL 522 GR	Erdei fenyő/Pine	4 x 22	24	5996025046664	<b>1408071</b>
DL 530 GR	Erdei fenyő/Pine	4 x 30	48	5996025046671	<b>1408072</b>
DL 622 GR	Erdei fenyő/Pine	6 x 22	48	5996025046817	<b>1408073</b>
DL 640 GR	Erdei fenyő/Pine	6 x 37	30	5996025046824	<b>1408074</b>
BA 714 M	Marupa	6 x 14	48	5996025046619	<b>1408090</b>
BA 722 M	Marupa	6 x 22	48	5996025046626	<b>1408091</b>
BA 724 M	Marupa	6 x 22	48	5996025046633	<b>1408092</b>
BA 831 GRT	Erdei fenyő/Pine	8 x 30	24	5996025046787	<b>1408093</b>
BA 1022 GRT	Erdei fenyő/Pine	9 x 22	48	5996025046794	<b>1408094</b>
BA 1022 M	Marupa	9 x 22	24	5996025046657	<b>1408095</b>

## Termékcsoport / Product range

### 1.22

#### Darabolt lécek Small length mouldings



HO 722

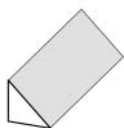

DR 2020



GL 915

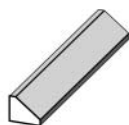

GL 1014

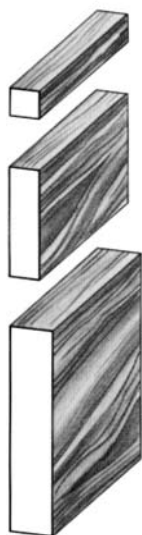

SL

JÉWÉ megnevezés JÉWÉ product name	Alapanyag Material	Méret (mm) Size (mm)	Megrendelési egység Order unit	EAN kód EAN code	JÉWÉ kód JÉWÉ code	
					105 cm	120 cm
HO 722 GR	Erdei fenyő/Pine	6 x 22	48	5996025046701	<b>1408110</b>	
DR 2020 V	Lucfenyő/Whitewood	20 x 20	48	5996025046725	<b>1408120</b>	
GL 915 GR	Erdei fenyő/Pine	9 x 15	50	5996025046718		<b>1408130</b>
GL 1014 GR	Erdei fenyő/Pine	9 x 13	48	5996025046831		<b>1408131</b>
SL 7x7 V	Lucfenyő/Whitewood	7 x 7	48	5996025046930		<b>1408160</b>
SL 7x18 V	Lucfenyő/Whitewood	7 x 18	48	5996025046947		<b>1408161</b>
SL 7x27 V	Lucfenyő/Whitewood	7 x 27	72	5996025046855		<b>1408162</b>
SL 7x44 V	Lucfenyő/Whitewood	7 x 44	24	5996025046862		<b>1408163</b>
SL 12,5x12,5 V	Lucfenyő/Whitewood	12,5 x 12,5	42	5996025046879		<b>1408164</b>
SL 12x18 V	Lucfenyő/Whitewood	12 x 18	48	5996025046886		<b>1408165</b>
SL 12x27 V	Lucfenyő/Whitewood	12 x 27	42	5996025046893		<b>1408166</b>
SL 12x36 V	Lucfenyő/Whitewood	12 x 36	42	5996025046909		<b>1408167</b>
SL 18x18 V	Lucfenyő/Whitewood	18 x 18	20	5996025046916		<b>1408168</b>
SL 18x28 V	Lucfenyő/Whitewood	18 x 28	15	5996025046923		<b>1408169</b>
SL 18x36 V	Lucfenyő/Whitewood	18 x 36	15	5996025046848		<b>1408170</b>

## Termékcsoport / Product range

1.23

Balza hobby lécek  
Balsa hobby slats



Kis tömegű, teljesen csomómentes fából.  
Kiválóan alkalmas modellezésre és egyéb hobby célokra.

Lightweight, completely clear timber, is exceedingly adapted for modeling and other hobby purpose.

Alapanyag Material	Méret (mm) Size (mm)	Megrendelési egység Order unit	EAN kód EAN code	JÉWÉ kód JÉWÉ code 100 cm
Balzafa Balsawood	1 x 100	40	8711283332505	<b>1504000</b>
	2 x 100	30	8711283332512	<b>1504001</b>
	3 x 100	25	8711283332529	<b>1504002</b>
	4 x 100	15	8711283332536	<b>1504003</b>
	5 x 5	100	8711283332543	<b>1504004</b>
	5 x 8	100	8711283332550	<b>1504005</b>
	5 x 15	48	8711283332567	<b>1504006</b>
	5 x 20	48	8711283332369	<b>1504007</b>
	5 x 100	15	8711283332376	<b>1504008</b>
	6 x 100	12	8711283332383	<b>1504009</b>
	8 x 8	50	8711283332390	<b>1504010</b>
	8 x 100	10	8711283332406	<b>1504011</b>
	10 x 10	50	8711283332413	<b>1504012</b>
	10 x 20	40	8711283332420	<b>1504013</b>
	10 x 100	10	8711283332437	<b>1504014</b>
	15 x 15	25	8711283332444	<b>1504015</b>
	15 x 100	6	8711283332451	<b>1504016</b>
20 x 100	5	8711283332468	<b>1504017</b>	
30 x 30	9	8711283332475	<b>1504018</b>	
30 x 50	6	8711283332482	<b>1504019</b>	
40 x 40	4	8711283332499	<b>1504020</b>	

## Termékcsoport / Product range

1.24

Alumínium és PVC profilok  
Aluminium and PVC profiles

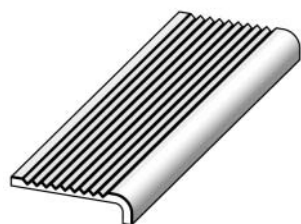

Szőnyegprofilok  
Stairsides

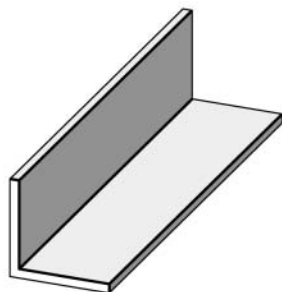

Sarokprofilok  
Angles

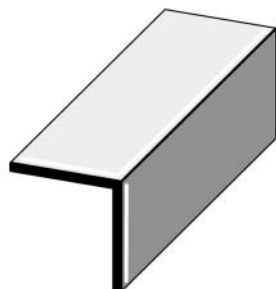

Sarokprofilok  
Angles

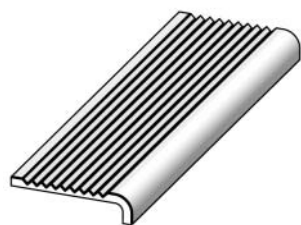
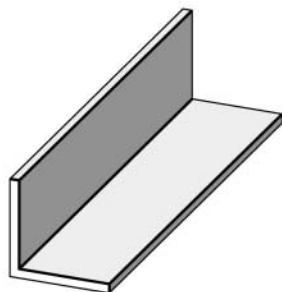
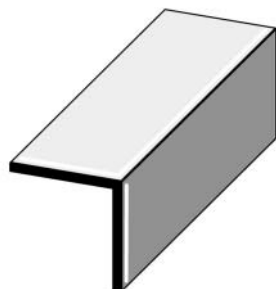
Termékcsoport / Product range	JÉWÉ megnevezés JÉWÉ product name	Méret (mm) Size (mm)	Megrendelési egység Order unit	JÉWÉ kód - EAN kód / JÉWÉ code - EAN code		
				200 cm	260 cm	
<p>Alumínium és PVC profilok Aluminium and PVC profiles</p>  <p>Szőnyegprofilok Stairsides</p>  <p>Sarokprofilok Angles</p>  <p>Sarokprofilok Angles</p>	Szőnyegprofilok Stairsides	20 x 17,5	8	<b>1410020</b> 8711283105765		
	Sarokprofilok Angles	20 x 20	8	<b>1410000</b> 8711283026947		
		25 x 25	8	<b>1410001</b> 8711283026954		
		30 x 30	8	<b>1410002</b> 8711283026961		
	Sarokprofilok Angles	2 mm vastag alumínium	Thickness aluminium 2 mm			
		Sarokprofilok Angles	15 x 15	20	<b>1409000</b> 8711283023861	
			20 x 20	20	<b>1409001</b> 8711283023878	
			25 x 25	20	<b>1409002</b> 8711283023885	
			30 x 30	20	<b>1409003</b> 8711283023892	
	Sarokprofilok Angles	35 x 35	20	<b>1409004</b> 8711283023908		
50 x 50		20	<b>1409007</b> 8711283047263			
	Fehér PVC alapanyagból	Made of white PVC				

# JÉWE

ELEMENT  SYSTEM®

2

## FÉM FALI POLCRENDSZEREK METAL SHELVING SYSTEMS



## Termékcsoport / Product range

2.01

### Egysoros falsínes rendszer One slot rail system



#### Falsín 1 soros One slot rail

Egy lyuksoros  
Csomagolási egység: 2 db, fóliában  
Wrapped per 2 pieces in foil

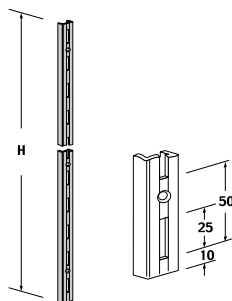

#### 2 horgas konzol Bracket with 2 claws

Az egy lyuksoros falsínekhez  
Teherbírás konzolonként: 55 kg  
Csomagolási egység: 1 db

Can be used with one slot rail  
Carrying capacity up to 55 kg  
Not wrapped, per box of 20 pieces





#### 3 horgas konzol Bracket with 3 claws

Az egy lyuksoros falsínekhez  
Teherbírás konzolonként: 65 kg

Can be used with one slot rail  
Carrying capacity up to 65 kg  
Not wrapped, per box of 20 pieces



Méret Size (cm)	Megrend. egység Order unit	JÉWÉ kód - EAN kód / JÉWÉ code - EAN code	
		FEHÉR WHITE	FEHÉR ALU. WHITE ALU.
50	10 pár 10 pair	 <b>1701000</b> 4006676000005	 <b>1701010</b> 4006676017638
100	10 pár 10 pair	<b>1701001</b> 4006676000029	<b>1701011</b> 4006676017645
150	5 pár 5 pair	<b>1701002</b> 4006676000043	<b>1701012</b> 4006676017652
200	5 pár 5 pair	<b>1701003</b> 4006676000067	<b>1701013</b> 4006676017669
15	20 db/pc	<b>1701050</b> 4006676008353	<b>1701070</b> 4006676017577
20	20 db/pc	<b>1701051</b> 4006676008377	<b>1701071</b> 4006676017584
25	20 db/pc	<b>1701052</b> 4006676008391	<b>1701072</b> 4006676017591
30	20 db/pc	<b>1701053</b> 4006676008414	<b>1701073</b> 4006676017607
35	20 db/pc	<b>1701054</b> 4006676008438	<b>1701074</b> 4006676046898
40	20 db/pc	<b>1701055</b> 4006676008452	<b>1701075</b> 4006676017621
50	20 db/pc	<b>1701056</b> 4006676008476	<b>1701076</b> 4006676057672
60	20 db/pc	<b>1701057</b> 4006676008490	



## Termékcsoport / Product range

2.02

### Duplasoros falsínes rendszer Double slot rail system



### Falsín 2 soros Double slot rail

Kétlyuksoros  
Csomagolási egység: 2 db fóliában  
Wrapped per 2 pieces in foil

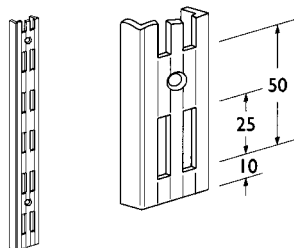





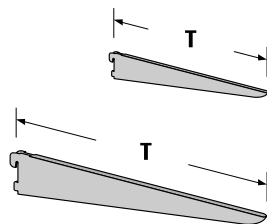

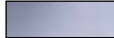
### U konzol U bracket

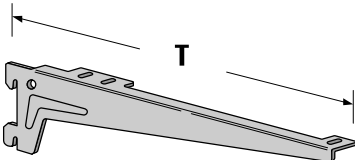
Kétlyuksoros falsínhez  
Teherbírás konzolonként: 55 kg  
Teherbírás a 170 mm-es  
konzolnál: 50 kg  
Csomagolási egység: 1 db  
Can be used with double slot rail  
Carrying capacity up to 55 kg  
Carrying capacity (170 mm bracket)  
up to 50 kg  
Not wrapped, per box of 20 pieces

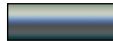

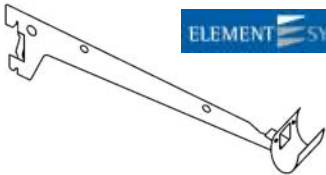
Méret Size (cm)	Megrend. egység Order unit	JÉWÉ kód - EAN kód / JÉWÉ code - EAN code	
		FEHÉR WHITE	FEHÉR ALU. WHITE ALU.
50	10 pár 10 pair	 <b>1702000</b> 4006676000180	 <b>1702010</b> 4006676026876
100	10 pár 10 pair	<b>1702001</b> 4006676000197	<b>1702011</b> 4006676026883
150	5 pár 5 pair	<b>1702002</b> 4006676000203	<b>1702012</b> 4006676026890
200	5 pár 5 pair	<b>1702003</b> 4006676000210	<b>1702013</b> 4006676026906
17	20 db/pc	<b>1702051</b> 4006676008650	<b>1702071</b> 4006676026975
22	20 db/pc	<b>1702052</b> 4006676008674	<b>1702072</b> 4006676027170
27	20 db/pc	<b>1702053</b> 4006676008698	<b>1702073</b> 4006676026517
37	20 db/pc	<b>1702054</b> 4006676008711	<b>1702074</b> 4006676026982
47	20 db/pc	<b>1702055</b> 4006676008735	<b>1702075</b> 4006676026999

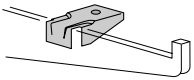
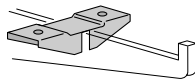
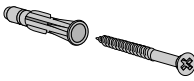
Termékcsoport / Product range	Méret Size (cm)	Megrend. egység Order unit	JÉWÉ kód - EAN kód / JÉWÉ code - EAN code		
			FEHÉR WHITE	FÉM METAL	FEHÉR ALU. WHITE ALU.
<b>2.03</b> <b>Szögkonzol 2 horgas</b> <b>Angle bracket</b> Kompatibilis minden típusú falsínnel Teherbírás konzolonként: 55 kg Csomagolási egység: 1 pár Can be used with all types of rails Carrying capacity up to 55 kg Wrapped per 1 pair	 	18 10 pár/pair 23 10 pár/pair 28 10 pár/pair 33 10 pár/pair 38 10 pár/pair 48 10 pár/pair	 <b>1705001</b> 4006676017393 <b>1705002</b> 4006676017379 <b>1705003</b> 4006676017355 <b>1705004</b> 4006676017331 <b>1705005</b> 4006676017317 <b>1705006</b> 4006676017294	 <b>1705021</b> 4006676050109 <b>1705022</b> 4006676026692 <b>1705023</b> 4006676034581 <b>1705024</b> 4006676027187 <b>1705025</b> 4006676050154	
<b>2.04</b> <b>Csőtartó konzol / Tube holder bracket</b>	 	25 10 db/pc 33 10 db/pc	<b>1705040</b> 4006676034130 <b>1705041</b> 4006676034185		
<b>2.05</b> <b>Kiegészítő alkatrészek / Accessories</b>		2,5 x 1 10 csom/pack 4,5 x 1 10 csom/pack 10 csom/pack		<b>1703021</b> 4006676016242 <b>1703020</b> 4006676016235 <b>1703000</b> 4006676000302	
<b>Lapfelerősítő egyoldalas</b> <b>Clip-on holder, single sided</b>		A 2 és a 3 horgas konzolhoz Csomagolási egység: 12 db Can be used with brackets with 2 and 3 claws Wrapped per 12 pieces			
<b>Lapfelerősítő kétoldalas</b> <b>Clip-on holder, two sided</b>					
<b>Csavar+tipli</b> <b>Screws and wall plugs</b>		Csavarok: 4,5 x 50 mm Csomagolási egység: 18 db Screws: 4,5 x 50 mm Wrapped per 18 pieces			

## Termékcsoport / Product range

2.06

Fémkonzolok, polctartók  
Metal brackets





Basic létrakonzolok  
Basic scale brackets



Konzol szerelési csomag  
Bracket accessory packet



Polc szerelési csomag  
Shelf accessory packet

JÉWÉ megnevezés JÉWÉ product name	Méret Size (cm)	Megrend. egység Order unit	JÉWÉ kód - EAN kód / JÉWÉ code - EAN code	
			FEHÉR WHITE	EZÜST SILVER
Létrakonzolok Scale brackets	20 x 20	4 db/pc	 <b>1707000</b> 4006676040902	 <b>1707010</b> 4006676040919
	20 x 30	4 db/pc	<b>1707001</b> 4006676040926	<b>1707011</b> 4006676040933
	54 x 20	4 db/pc	<b>1707002</b> 4006676040827	<b>1707012</b> 4006676040834
	54 x 30	4 db/pc	<b>1707003</b> 4006676040841	<b>1707013</b> 4006676040858
	90 x 20	4 db/pc	<b>1707004</b> 4006676040865	<b>1707014</b> 4006676040872
	90 x 30	4 db/pc	<b>1707005</b> 4006676040889	<b>1707015</b> 4006676040896
Konzol szerelési csomag Bracket accessory packet		1 csom/pack	<b>1707050</b> 4006676046515	
Polc szerelési csomag Shelf accessory packet		1 csom/pack	<b>1707051</b> 4006676046508	

## Termékcsoport / Product range

2.06

### Fémkonzolok, polctartók Metal brackets

Ovális konzol - PO  
Oval bracket - PO



Eladási egység: 1 db  
Megrendelési egység: 10 db  
Teherbírás konzolonként: 40 kg  
Not wrapped, per box of 10 pieces  
Carrying capacity up to 40 kg

19

10 db/pc

**1706000**  
5996025049436

**1706001**  
5996025049443

**1706002**  
5996025049450

Rácsos konzol - PR  
Truss bracket - PR



Eladási egység: 1 db  
Megrendelési egység: 10 db  
Teherbírás konzolonként: 40 kg  
Not wrapped, per box of 10 pieces  
Carrying capacity up to 40 kg

19

10 db/pc

**1706010**  
5996025049467

**1706011**  
5996025049474

**1706012**  
5996025049481

Díszített konzol - PD  
Pitted bracket - PD



Eladási egység: 1 db  
Megrendelési egység: 10 db  
Teherbírás konzolonként: 40 kg  
Not wrapped, per box of 10 pieces  
Carrying capacity up to 40 kg

30

10 db/pc

**1706020**  
5996025049399

**1706021**  
5996025049405

**1706022**  
5996025049412

Kovácsoltvas konzol  
Wrought iron bracket



Eladási egység: 1 db  
Megrendelési egység: 10 db  
Teherbírás konzolonként: 10 kg  
Not wrapped, per box of 10 pieces  
Carrying capacity up to 10 kg

15 x 20

10 db/pc

**1706030**  
8714019009061

20 x 27,5

10 db/pc

**1706031**  
8714019009078

Félhold alakú konzol  
Crescent bracket



Eladási egység: 1 db  
Megrendelési egység: 10 db  
Teherbírás konzolonként: 10 kg  
Not wrapped, per box of 10 pieces  
Carrying capacity up to 10 kg

19 x 19





10 db/pc

**1706040**  
8711283346083

24 x 24

10 db/pc

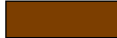
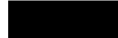
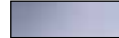
**1706041**  
8711283346076

Termékcsoport / Product range	Méret Size (cm)	Megrend. egység Order unit	JÉWÉ kód - EAN kód / JÉWÉ code - EAN code			
			FEHÉR WHITE	BARNA BROWN	FEKETE BLACK	EZÜST SILVER
<b>2.06</b> <b>Fémkonzolok, polctartók</b> <b>Metal brackets</b>  <b>Háromszögű design</b> <b>konzol</b> <b>Bracket triangle design</b>  Csomagolási egység: 1 db Teherbírás konzolonként: 25 kg Not wrapped, per box of 20 pieces Carrying capacity up to 25 kg  	19 x 19	20 db/pc	 <b>1706070</b> 8711283339566			 <b>1706071</b> 8711283339573
<b>Fémkonzol - PB</b> <b>Metal bracket - PB</b>  Csomagolási egység: 1 db Teherbírás konzolonként: 40 kg Not wrapped, per box of 20 pieces Carrying capacity up to 40 kg  	14 x 20	20 db/pc	<b>1706080</b> 5996025058063		<b>1706081</b> 5996025058070	<b>1706082</b> 5996025058087
  <b>Acéllemezkonzol - AK</b> <b>Steel sheet brackets - AK</b>  Csomagolási egység: 1 db Teherbírás konzolonként: 16-35 kg Not wrapped, per box of 20 pieces Carrying capacity up to 16-35 kg	10 x 12,5	20 db/pc	<b>1711000</b> 8714019001652	<b>1711001</b> 8714019002949	<b>1711002</b> 8714019004431	<b>1711003</b> 5996025052962
	15 x 20	20 db/pc	<b>1711010</b> 8714019001676	<b>1711011</b> 8714019002963	<b>1711012</b> 8714019004455	<b>1711013</b> 5996025052979
	20 x 25	20 db/pc	<b>1711020</b> 8714019001690	<b>1711021</b> 8714019002987	<b>1711022</b> 8714019004479	<b>1711023</b> 5996025052986
	25 x 30	20 db/pc	<b>1711030</b> 8714019001706	<b>1711031</b> 8714019002994	<b>1711032</b> 8714019004486	<b>1711033</b> 5996025052993
	30 x 35	20 db/pc	<b>1711040</b> 8714019001720	<b>1711041</b> 8714019003007	<b>1711042</b> 8714019004493	<b>1711043</b> 5996025053006

## Termékcsoport / Product range

2.06

### Fémkonzolok, polctartók Metal brackets



Teherbírás konzolonként:  
Carrying capacity:  
12 x 8 cm: 16 kg  
17 x 12 cm: 16 kg  
22 x 15,5 cm: 24 kg  
27 x 19 cm: 32 kg  
32 x 22 cm: 35 kg



### Felcsavarozható konzol Screw-up brackets

Csomagolási egység: 1 db

Not wrapped, per box of 20 pieces



### Nehézkonzol - PT Heavy bracket - PT

Csomagolási egység: 1 db

Not wrapped, per box of 10 pieces







Teherbírás konzolonként:  
Carrying capacity:  
30 cm: 40 kg  
40 cm: 50 kg  
50 cm: 60 kg



### Ipari konzol Industrial bracket

Csomagolási egység: 1 db

Not wrapped, per box of 10 pieces

Méret Size (cm)	Megrend. egység Order unit	JÉWÉ kód - EAN kód / JÉWÉ code - EAN code		
		FEHÉR WHITE	FEKETE BLACK	EZÜST SILVER
12 x 8	20 db/pc	 <b>1709000</b> 4006676001361	 <b>1709001</b> 4006676008025	 <b>1709002</b> 4006676008025
17 x 12	20 db/pc	<b>1709010</b> 4006676001378	<b>1709011</b> 4006676008032	<b>1709012</b> 4006676008032
22 x 15,5	20 db/pc	<b>1709020</b> 4006676001385	<b>1709021</b> 4006676008049	<b>1709022</b> 4006676008049
27 x 19	20 db/pc	<b>1709030</b> 4006676001392	<b>1709031</b> 4006676008056	<b>1709032</b> 4006676008056
32 x 22	20 db/pc	<b>1709040</b> 4006676001408	<b>1709041</b> 4006676008063	<b>1709042</b> 4006676008063
8 x 12	10 db/pc	<b>1708000</b> 5996025049214	<b>1708001</b> 5996025049221	<b>1708002</b> 5996025049238
16 x 18	10 db/pc	<b>1708010</b> 5996025049245	<b>1708011</b> 5996025049252	<b>1708012</b> 5996025049269
18 x 22	10 db/pc	<b>1708020</b> 5996025049276	<b>1708021</b> 5996025049283	<b>1708022</b> 5996025049290
22 x 26	10 db/pc	<b>1708030</b> 5996025049306	<b>1708031</b> 5996025049313	<b>1708032</b> 5996025049320
26 x 30	10 db/pc	<b>1708040</b> 5996025049337	<b>1708041</b> 5996025049344	<b>1708042</b> 5996025049351
21 x 30	10 db/pc	<b>1710000</b> 5997447300174		<b>HORGANYZOTT</b> szinkód: ..-8 <b>GALVANIZED</b> color code: ..-8  <b>1710001</b> 5997447300181
27 x 40	10 db/pc	<b>1710010</b> 5997447300198		<b>1710011</b> 5997447300204
33 x 50	10 db/pc	<b>1710020</b> 5997447300211		<b>1710021</b> 5997447300228

## Termékcsoport / Product range

2.07

### Szerszámfal rendszer / Workshop organizer system



#### Perforált lemez Perforated sheet

Szerelhető falsínre vagy anélkül  
Csomagolási egység: 1 pár  
Wrapped per 2 pieces in foil  
Can be used with or without rail



#### Fém polclap Metal shelf

Teherbírási polclemezenként 30 kg  
Csomagolási egység: 1 pár  
Carrying capacity up to 30 kg  
Wrapped per 2 pieces in foil  
Order unit 1 pair



#### Drótkosár fehér konzollal Metal rack with white bracket

Teherbírási drótkosaranként 20 kg  
Csomagolási egység: 1 db  
Carrying capacity up to 20 kg  
Not wrapped, per box of 10 pieces  
Order unit 1 piece



#### Fém szerszám tartó akasztó, hosszú Metal tool hanger, long

Csomagolási egység: 4 db  
Wrapped per 4 pieces  
Order unit: 10 packs



#### Fém szerszám tartó akasztó, rövid Metal tool hanger, short

Csomagolási egység: 4 db  
Wrapped per 4 pieces  
Order unit: 10 packs



#### Ívelt szerszám tartó, 2 db Tool hanger, cambered (2 pcs)



Méret Size (cm)	Megrend. egység Order unit	EAN kód / EAN code	JÉWÉ kód / JÉWÉ code
		FEHÉR WHITE	HORGANYZOTT GALVANIZED
80 x 20	1 pár/pair		
		<b>1704000</b> 4006676016730	
		<b>1704010</b> 4006676006984	
		<b>1704011</b> 4006676007011	
		<b>1704012</b> 4006676007042	
80 x 30	1 db/pc	<b>1704023</b> 4006676003143	
20 x 0,7 Ø	10 csom/pack		<b>1704060</b> 4006676016105
12 x 0,7 Ø	10 csom/pack		<b>1704061</b> 4006676001194
63 x 75	10 pár/pair	<b>1704080</b> 4006676001231	

## Termékcsoport / Product range

2.08

Fém asztallábak / Steel table legs



Acélcső láb, négyzetletű  
Steel table leg, rectangular

25 x 25 mm, M 10 menettel  
Csomagolási egység: 1 db

25 x 25 mm, M 10 screw-thread  
Not wrapped, per box of 4 pieces



Acélcső láb, hengeres  
Steel table leg, cylindrical







Ø 30 mm  
Csomagolási egység: 1 db

Ø 30 mm  
Not wrapped, per box of 4 pieces

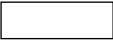

Méret Size (cm)	Megrend. egység Order unit	JÉWÉ kód - EAN kód / JÉWÉ code - EAN code		
		FEHÉR WHITE	FEKETE BLACK	FEHÉR ALU. WHITE ALU.
10	4 db/pc	<b>1713000</b> 4006676010615	<b>1713001</b> 4006676010622	<b>1713002</b> 4006676032471
20	4 db/pc	<b>1713010</b> 4006676010714	<b>1713011</b> 4006676010721	<b>1713012</b> 4006676033607
30	4 db/pc	<b>1713020</b> 4006676010813	<b>1713021</b> 4006676010820	<b>1713022</b> 4006676034093
40	4 db/pc	<b>1713030</b> 4006676010912	<b>1713031</b> 4006676010929	<b>1713032</b> 4006676033058
70	4 db/pc	<b>1713040</b> 4006676011216	<b>1713041</b> 4006676011223	<b>1713042</b> 4006676033140
80	4 db/pc	<b>1713060</b> 4006676011315	<b>1713061</b> 4006676011322	<b>1713062</b> 4006676032419
10	4 db/pc	<b>1713100</b> 4006676011360	<b>1713101</b> 4006676011377	<b>1713102</b> 4006676028511
20	4 db/pc	<b>1713110</b> 4006676011476	<b>1713111</b> 4006676011483	<b>1713112</b> 4006676028399
30	4 db/pc	<b>1713120</b> 4006676011575	<b>1713121</b> 4006676011582	<b>1713122</b> 4006676028405
40	4 db/pc	<b>1713130</b> 4006676011674	<b>1713131</b> 4006676011681	<b>1713132</b> 4006676028535
70	4 db/pc	<b>1713140</b> 4006676011995	<b>1713141</b> 4006676012008	<b>1713142</b> 4006676028542
75	4 db/pc	<b>1713150</b> 4006676012046	<b>1713151</b> 4006676012053	<b>1713152</b> 4006676028559
80	4 db/pc	<b>1713160</b> 4006676012091	<b>1713161</b> 4006676012107	<b>1713162</b> 4006676028566

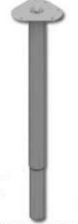

Termékcsoport / Product range	Méret Size (cm)	Megrend. egység Order unit	JÉWÉ kód - EAN kód / JÉWÉ code - EAN code					
			FEHÉR WHITE	FEKETE BLACK	KRÓM CHROME	FEHÉR ALU. WHITE ALU.	INOX INOX	
<b>2.08</b> <b>Fém asztallábak / Steel table legs</b>  <b>Fortuna asztalláb szett (4 db)</b> <b>Fortuna steel table leg set (set of 4 pcs)</b> Ø 60 mm Csomagolási egység: 4 db/karton Ø 60 mm Wrapped per 4 pieces		72-75	1csom/pack	 <b>1713210</b> 8711283333007			 <b>1713213</b> 8711283333021	
		40	4 db/pc				<b>1713171</b> 4006676026708	
<b>Acélszóláb</b> <b>Steel table leg</b> Ø 60 mm Csomagolási egység: 1 db Ø 60 mm Not wrapped, per box of 4 pieces		70	4 db/pc	<b>1713180</b> 4006676010561	<b>1713181</b> 4006676010578	<b>1713182</b> 4006676010592	<b>1713172</b> 4006676026753	
		80	4 db/pc			<b>1713190</b> 4006676020584	<b>1713173</b> 4006676034086	
		90	4 db/pc	<b>1713175</b> 4006676024049	<b>1713176</b> 4006676024056			<b>1713178</b> 4006676117994
		110	4 db/pc	<b>1713196</b> 4006676027224		<b>1713199</b> 4006676040261		
<b>Szintezőcsavar</b> <b>Adjusting screw</b> M 10 menettel Csomagolási egység: 4 db  With M 10 screw-thread Selling unit: 1 pack (4 pcs) Ordering unit: 10 packages		Ø 3	10 csom/pack			<b>1713201</b> 4006676016198		
<b>Teleszkópos acélláb</b> <b>Telescopic table leg</b> Ø 50 mm Csomagolási egység: 1 db Ø 50 mm Not wrapped, per box of 4 pieces		60-90	4 db/pc		<b>1713165</b> 4006676111121		<b>1713166</b> 4006676089284	
		80-120	4 db/pc	<b>1713167</b> 4006676111169				



# JÉWE

3

***POLCLAPOK, - SZETTEK, - TARTÓK  
SHELVES AND BRACKETS***



## Termékcsoport Product range







### 3.01

### Laminált polclapok Laminated shelves



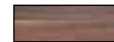

18 mm vastag bútorlapból,  
négy oldalon élfóliázva

Panel board thickness 18 mm,  
edge foiled on four sides

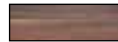

Méret Size (cm)	Megrend. egység Order unit	JÉWÉ kód - EAN kód / JÉWÉ code - EAN code						
		FEHÉR WHITE	WENGE WENGE	JUHAR MAPLE	BÜKK BEECH	CSERESZNYE CHERRY	SONOMA TÖLGY SONOMA OAK	SZILVA PLUM
60 x 20	1	 <b>2101000</b> 5996025111201	 <b>2101040</b> 5996025057639	 <b>2101080</b> 5996025057066	 <b>2101120</b> 5996025041201	 <b>2101160</b> 5996025041515	 <b>2101400</b> 5996025060912	 <b>2101440</b> 5996025061094
60 x 25	1	<b>2101001</b> 5996025111256	<b>2101041</b> 5996025057646	<b>2101081</b> 5996025057073	<b>2101121</b> 5996025041218	<b>2101161</b> 5996025041522	<b>2101401</b> 5996025060929	<b>2101441</b> 5996025061100
60 x 30	1	<b>2101002</b> 5996025111300	<b>2101042</b> 5996025057653	<b>2101082</b> 5996025057080	<b>2101122</b> 5996025041225	<b>2101162</b> 5996025041539	<b>2101402</b> 5996025061131	<b>2101442</b> 5996025061117
60 x 40	1	<b>2101003</b> 5996025111409	<b>2101043</b> 5996025057660	<b>2101083</b> 5996025057097	<b>2101123</b> 5996025041232	<b>2101163</b> 5996025041546	<b>2101403</b> 5996025061148	<b>2101443</b> 5996025061124
80 x 20	1	<b>2101010</b> 5996025112208	<b>2101050</b> 5996025057677	<b>2101090</b> 5996025057103	<b>2101130</b> 5996025041249	<b>2101170</b> 5996025041553	<b>2101410</b> 5996025060332	<b>2101450</b> 5996025060516
80 x 25	1	<b>2101011</b> 5996025112253	<b>2101051</b> 5996025057684	<b>2101091</b> 5996025057110	<b>2101131</b> 5996025041256	<b>2101171</b> 5996025041560	<b>2101411</b> 5996025060349	<b>2101451</b> 5996025060523
80 x 30	1	<b>2101012</b> 5996025112307	<b>2101052</b> 5996025057691	<b>2101092</b> 5996025057127	<b>2101132</b> 5996025041263	<b>2101172</b> 5996025041577	<b>2101412</b> 5996025060356	<b>2101452</b> 5996025060530
80 x 40	1	<b>2101013</b> 5996025112406	<b>2101053</b> 5996025057707	<b>2101093</b> 5996025057134	<b>2101133</b> 5996025041270	<b>2101173</b> 5996025041584	<b>2101413</b> 5996025060363	<b>2101453</b> 5996025060547
80 x 50	1	<b>2101014</b> 5996025112505						
100 x 20	1	<b>2101020</b> 5996025113205	<b>2101060</b> 5996025057714	<b>2101100</b> 5996025057141	<b>2101140</b> 5996025041294	<b>2101180</b> 5996025041607	<b>2101420</b> 5996025061032	<b>2101460</b> 5996025060998
100 x 25	1	<b>2101021</b> 5996025113250	<b>2101061</b> 5996025057721	<b>2101101</b> 5996025057158	<b>2101141</b> 5996025041300	<b>2101181</b> 5996025041614	<b>2101421</b> 5996025061049	<b>2101461</b> 5996025061001
100 x 30	1	<b>2101022</b> 5996025113304	<b>2101062</b> 5996025057738	<b>2101102</b> 5996025057165	<b>2101142</b> 5996025041317	<b>2101182</b> 5996025041621	<b>2101422</b> 5996025061056	<b>2101462</b> 5996025061018
100 x 40	1	<b>2101023</b> 5996025113403	<b>2101063</b> 5996025057745	<b>2101103</b> 5996025057172	<b>2101143</b> 5996025041324	<b>2101183</b> 5996025041638	<b>2101423</b> 5996025061063	<b>2101463</b> 5996025061025
100 x 50	1	<b>2101024</b> 5996025113502						
120 x 20	1	<b>2101030</b> 5996025114202	<b>2101070</b> 5996025057752	<b>2101110</b> 5996025057189	<b>2101150</b> 5996025041348	<b>2101190</b> 5996025041652	<b>2101430</b> 5996025060370	<b>2101470</b> 5996025060554
120 x 25	1	<b>2101031</b> 5996025114257	<b>2101071</b> 5996025057769	<b>2101111</b> 5996025057196	<b>2101151</b> 5996025041355	<b>2101191</b> 5996025041669	<b>2101431</b> 5996025060387	<b>2101471</b> 5996025060561
120 x 30	1	<b>2101032</b> 5996025114301	<b>2101072</b> 5996025057776	<b>2101112</b> 5996025057202	<b>2101152</b> 5996025041362	<b>2101192</b> 5996025041676	<b>2101432</b> 5996025060394	<b>2101472</b> 5996025060578
120 x 40	1	<b>2101033</b> 5996025114400	<b>2101073</b> 5996025057783	<b>2101113</b> 5996025057219	<b>2101153</b> 5996025041379	<b>2101193</b> 5996025041683	<b>2101433</b> 5996025060400	<b>2101473</b> 5996025060585
120 x 50	1	<b>2101034</b> 5996025114509						

## Termékcsoport Product range

Termékcsoport Product range	Méret Size (cm)	Megrend. egység Order unit	JÉWÉ kód - EAN kód / JÉWÉ code - EAN code						
			FEHÉR WHITE	WENGE WENGE	JUHAR MAPLE	BÜKK BEECH	CSERESZNYE CHERRY	SONOMA TÖLGY SONOMA OAK	SZILVA PLUM
<b>3.02</b>  <b>Laminált polcpanelek</b> <b>Laminated boards</b>  18 mm vastag bútortalpból, hosszanti oldalain élfóliázva  Panel board thickness 18 mm, edge foiled on the lengthy sides  	260 x 20	1	 <b>2102000</b> 5996025040891	 <b>2102010</b> 5996025057790	 <b>2102020</b> 5996025057226	 <b>2102030</b> 5996025041454	 <b>2102040</b> 5996025041768	 <b>2102100</b> 5996025060417	 <b>2102110</b> 5996025060592
	260 x 25	1	<b>2102001</b> 5996025040907	<b>2102011</b> 5996025057806	<b>2102021</b> 5996025057233	<b>2102031</b> 5996025041461	<b>2102041</b> 5996025041775	<b>2102101</b> 5996025060424	<b>2102111</b> 5996025060608
	260 x 30	1	<b>2102002</b> 5996025040914	<b>2102012</b> 5996025057813	<b>2102022</b> 5996025057240	<b>2102032</b> 5996025041478	<b>2102042</b> 5996025041782	<b>2102102</b> 5996025060431	<b>2102112</b> 5996025060615
	260 x 40	1	<b>2102003</b> 5996025040921	<b>2102013</b> 5996025057820	<b>2102023</b> 5996025057257	<b>2102033</b> 5996025041485	<b>2102043</b> 5996025041799	<b>2102103</b> 5996025060448	<b>2102113</b> 5996025060622
	260 x 50	1	<b>2102004</b> 5996025040938	<b>2102014</b> 5996025057837	<b>2102024</b> 5996025057264	<b>2102034</b> 5996025041492	<b>2102044</b> 5996025041805	<b>2102104</b> 5996025060455	<b>2102114</b> 5996025060639
	260 x 60	1	<b>2102005</b> 5996025040945	<b>2102015</b> 5996025057844	<b>2102025</b> 5996025057271	<b>2102035</b> 5996025041508	<b>2102045</b> 5996025041812	<b>2102105</b> 5996025060462	<b>2102115</b> 5996025060646
<b>3.03</b>  <b>Laminált sarokpolcok</b> <b>Laminated corner-shelves</b>  18 mm vastag bútortalpból körben élfóliázva  Panel board thickness 18 mm, edge foiled on round  	20 x 20	5	<b>1902000</b> 5996025310208			<b>1902010</b> 5996025042130	<b>1902020</b> 5996025042277		
	25 x 25	5	<b>1902001</b> 5996025310253			<b>1902011</b> 5996025042147	<b>1902021</b> 5996025042284	<b>1902051</b> 5996025060936	
	30 x 30	5	<b>1902002</b> 5996025310307			<b>1902012</b> 5996025042154	<b>1902022</b> 5996025042291	<b>1902053</b> 5996025060943	
	35 x 35	5	<b>1902003</b> 5996025310352			<b>1902013</b> 5996025042161	<b>1902023</b> 5996025042307		
	40 x 40	5	<b>1902004</b> 5996025310406			<b>1902014</b> 5996025042178			
<b>3.04</b>  <b>Élfóliák</b> <b>Side-foils</b>  22 mm széles, ragasztózott, fóliába csomagolva  22 mm wide, with glue back size packed in a foil  	meter								
	3 m	10	<b>2103000</b> 5996025042437			<b>2103030</b> 5996025042512	<b>2103040</b> 5996025042598		
	5 m	10	<b>2103001</b> 5996025042444			<b>2103031</b> 5996025042529	<b>2103041</b> 5996025042604		
	10 m	5	<b>2103002</b> 5996025042451			<b>2103032</b> 5996025042536	<b>2103042</b> 5996025042611		
30 m	5	<b>2103003</b> 5996025042468							

## Termékcsoport Product range

3.05

### Regalo polcok Regalo shelves



Regalo sarokpolcok  
Regalo corner-shelves













Regalo íves polcok  
Regalo cambered shelves



Regalo polcok  
Regalo shelves

JÉWÉ megnevezés JÉWÉ product name	Méret Size (cm)	Megrend. egység Order unit	JÉWÉ kód - EAN kód / JÉWÉ code - EAN code						
			BÜKK BEECH	CSERESZNYE CHERRY	CREMONA TÖLGY CREMONA OAK	FERRARA TÖLGY FERRARA OAK	ROMANA CSERESZNYE ROMANA CHERRY	FEHÉR WHITE	
Regalo sarokpolcok Regalo corner-shelves	20 x 20	5							
	25 x 25	5	<b>1901001</b> 5996025049627	<b>1901011</b> 5996025049726	<b>1901021</b> 5996025056762	<b>1901031</b> 5996025056861	<b>1901051</b> 5996025057301		
	30 x 30	5			<b>1901022</b> 5996025057868	<b>1901032</b> 5996025057882			
	35 x 35	5	<b>1901003</b> 5996025049634	<b>1901013</b> 5996025049733	<b>1901023</b> 5996025056779	<b>1901033</b> 5996025056878	<b>1901053</b> 5996025057318		
Regalo íves polcok Regalo cambered shelves	60 x 15	5	<b>1901100</b> 5996025049689	<b>1901110</b> 5996025049788	<b>1901120</b> 5996025056823	<b>1901130</b> 5996025056922			
	60 x 25	5	<b>1901101</b> 5996025049696	<b>1901111</b> 5996025049795	<b>1901121</b> 5996025056830	<b>1901131</b> 5996025056939	<b>1901151</b> 5996025057370		
	80 x 15	5	<b>1901102</b> 5996025049702	<b>1901112</b> 5996025049801					
	80 x 25	5	<b>1901103</b> 5996025049719	<b>1901113</b> 5996025049818	<b>1901123</b> 5996025056854	<b>1901133</b> 5996025056953	<b>1901153</b> 5996025057394		
Regalo polcok Regalo shelves	60 x 15	5	<b>1901200</b> 5996025049641	<b>1901210</b> 5996025049740	<b>1901220</b> 5996025056786	<b>1901230</b> 5996025056885	<b>1901250</b> 5996025057325		
	60 x 20	5	<b>1901201</b> 5996025052252					<b>1901261</b> 5996025052290	
	60 x 25	5	<b>1901202</b> 5996025049658	<b>1901212</b> 5996025049757	<b>1901222</b> 5996025056793	<b>1901232</b> 5996025056892	<b>1901252</b> 5996025057332		
	60 x 30	5	<b>1901203</b> 5996025052269					<b>1901263</b> 5996025052306	
	80 x 15	5	<b>1901204</b> 5996025049665	<b>1901214</b> 5996025049764					
	80 x 20	5	<b>1901205</b> 5996025052276					<b>1901265</b> 5996025052313	
	80 x 25	5	<b>1901206</b> 5996025049672	<b>1901216</b> 5996025049771	<b>1901226</b> 5996025056816	<b>1901236</b> 5996025056915	<b>1901256</b> 5996025057356		
80 x 30	5	<b>1901207</b> 5996025052283					<b>1901267</b> 5996025052320		

Termékcsoport / Product range	JÉWÉ megnevezés JÉWÉ product name	Méret Size (cm)	Megrend. egység Order unit	JÉWÉ kód - EAN kód / JÉWÉ code - EAN code				
				BÜKK BEECH	EZÜST SILVER	FEHÉR WHITE	FEKETE BLACK	
<b>3.06</b> <b>Lebegőpolcok</b> <b>Floating shelves</b>	Lebegőpolcok Floating shelves	80 x 25 x 4,5	1					
		120 x 25 x 4,5	1	<b>1903000</b> 8711283329840	<b>1903010</b> 8711283329857	<b>1903020</b> 8711283329895	<b>1903030</b> 8711283359694	
	Fóliába csomagolva, a felszereléshez szükséges alkatrészekkel együtt  Packed in foil with all accessories	80 x 25 x 4,5	1	<b>1903040</b> 8711283359670	<b>1903050</b> 8711283359656	<b>1903060</b> 8711283345079	<b>1903070</b> 8711283345086	
				<b>1903041</b> 8711283359687	<b>1903051</b> 8711283359663	<b>1903061</b> 8711283345093	<b>1903071</b> 8711283345062	
		120 x 25 x 4,5	1	<b>ZEBRANO</b> ZEBRANO		<b>USZADÉKFA</b> DRIFTWOOD	<b>WENGE</b> WENGE	<b>TÖLGY</b> OAK
								

<b>3.07</b> <b>Létrapolc szettek</b> <b>Scale bracket sets</b>	<b>Szimpla</b> tartalma: 1 db 60 x 20 cm-es lami- nált polc, 2 db 20x20 cm-es létrakonozól, csavarcsomag  <b>Dupla</b> tartalma: 2 db 60 x 20 cm-es lami- nált polc, 2 db 54 x 20 cm-es létrakonozól, csavarcsomag	60 x 20 x 20	1	<b>FEHÉR</b> WHITE	<b>BÜKK</b> BEECH		
						<b>1909030</b> 5996025052665	<b>1909040</b> 5996025052658
		60 x 20 x 54	1	<b>1909031</b> 5996025052498	<b>1909041</b> 5996025052504		

## Termékcsoport / Product range

### 3.08

#### Tömörfenyő polclapok Pine glue lam panels



JÉWÉ megnevezés JÉWÉ product name	Méret Size (cm)	Megrend. egység Order unit	EAN kód EAN code	JÉWÉ kód JÉWÉ code	
Tömörfenyő polclapok Pine glue lam panels	60 x 20	1	5996025011204	<b>2104000</b>	
	60 x 25	1	5996025011259	<b>2104001</b>	
	60 x 30	1	5996025011303	<b>2104002</b>	
	60 x 40	1	5996025011402	<b>2104003</b>	
	18 mm vastag ragasztott natúr lucfenyő polclap	80 x 20	1	8711283339627	<b>2104010</b>
		80 x 25	1	8711283331096	<b>2104011</b>
		80 x 30	1	8711283331102	<b>2104012</b>
		80 x 40	1	8711283331119	<b>2104013</b>
		80 x 50	1	8711283339610	<b>2104014</b>
		Sized natural whitewood board, thickness 18 mm	120 x 20	1	8711283339603
	120 x 25		1	8711283331126	<b>2104021</b>
	120 x 30		1	8711283331133	<b>2104022</b>
	120 x 40		1	8711283331140	<b>2104023</b>
	120 x 50		1	8711283339641	<b>2104024</b>
200 x 20	1		8711283339634	<b>2104030</b>	
200 x 25	1	8711283066189	<b>2104031</b>		
200 x 30	1	8711283054148	<b>2104032</b>		
200 x 40	1	8711283054216	<b>2104033</b>		
200 x 50	1	8711283013510	<b>2104034</b>		

### 3.09

#### Telefon- és sarokpolcok Telephone and corner-shelves



Fenyő telefonpolcok  
Pine telephone shelves



Fenyő sarokpolcok  
Pine corner-shelves

Telefonpolcok Telephone shelves	40 x 20	1	5996025214209	<b>1904000</b>
	40 x 25	1	5996025214254	<b>1904001</b>
	40 x 30	1	5996025214308	<b>1904002</b>
	60 x 20	1	5996025216203	<b>1904010</b>
	60 x 25	1	5996025216258	<b>1904011</b>
	60 x 30	1	5996025216302	<b>1904012</b>
Fenyő sarokpolcok Pine corner-shelves	20 x 20	3	5996025210201	<b>1902070</b>
	25 x 25	3	5996025210256	<b>1902071</b>
	30 x 30	3	5996025210300	<b>1902072</b>
18 mm vastag ragasztott fenyőből, két lekerekített sarokkal, fóliába csomagolva				
Sized whitewood with 2 round corners, thickness 18 mm, packed in foil				
18 mm vastag ragasztott fenyőből, fóliába csomagolva				
Sized whitewood, thickness 18 mm, packed in foil				





## Termékcsoport / Product range

3.10

### Polcszettek Small kit shelves



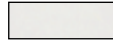





Basic sarokpolc szett  
Basic corner-shelf set

JÉWÉ megnevezés JÉWÉ product name	Méret Size (cm)	Megrend. egység Order unit	JÉWÉ kód - EAN kód / JÉWÉ code - EAN code		
			FENYŐ PINE	FEHÉR WHITE	BÜKK BEECH
PP-2 sarokpolc szett PP-2 corner-shelf set	25 x 25	1	 <b>1908000</b> 5996025030250		
PP-3 sarokpolc szett PP-3 corner-shelf set	30 x 30	1	<b>1908001</b> 5996025030359		
PP-4 virágtartó polcszett PP-4 houseplant-shelf set	20 x 20	1	<b>1908002</b> 5996025030458		
PP-5 virágtartó polcszett PP-5 houseplant-shelf set	25 x 25	1	<b>1908003</b> 5996025030557		
PP-10 íves polcszett PP-10 cambered shelf set	50 x 25	1	<b>1908004</b> 5996025031059		
PP-14 telefon polcszett PP-14 telephone-shelf set	60 x 20	1	<b>1908005</b> 5996025031554	<b>1908025</b> 5996025031516	<b>1908045</b> 5996025040792
PP-15 telefon polcszett PP-15 telephone-shelf set	60 x 25	1	<b>1908006</b> 5996025031455		
Basic polcszett, kicsi Basic shelf set, small	60 x 20	1	<b>1908007</b> 5996025043403		
Basic polcszett, nagy Basic shelf set, big	80 x 20	1	<b>1908008</b> 5996025043410		
Basic sarokpolc szett Basic corner-shelf set	25 x 25	1	<b>1908009</b> 5996025043427		
18 mm-es fenyő alapanyagból összeszerelési csomaggal együtt lapraszerelve fóliába csomagolva Made of pine wood, thickness 18 mm with accessories, knocked down, packed in foil			18 mm-es laminált bútortalpból összeszerelési csomaggal együtt lapraszerelve fóliába csomagolva Made of laminated panel board, thickness 18 mm with accessories, knocked down, packed in foil		

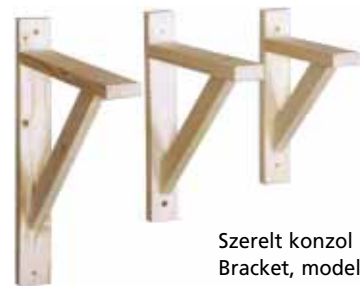
## Termékcsoport / Product range

3.11

### Fakonzolok Wooden brackets

Termékcsoport / Product range		JÉWÉ megnevezés JÉWÉ product name	Méret Size (cm)	Megrend. egység Order unit	EAN kód / EAN code	JÉWÉ kód / JÉWÉ code
		FENYŐ PINE				
 <p>Szerelt konzol Bracket, model 1</p>  <p>Derékszögű konzol Bracket, model 3</p>  <p>Szerelt-íves konzol Bracket, model 2</p>  <p>Konzol stil Bracket, model 4</p>  <p>Szerelt - mart konzol Bracket, model 5</p>  <p>Íves konzol Bracket, model 6</p>  <p>Mart konzol Bracket, model 7</p>	<p>Szerelt konzol Bracket, model 1</p> <p>Derékszögű konzol Bracket, model 3</p> <p>Szerelt-íves konzol Bracket, model 2</p> <p>Konzol stil Bracket, model 4</p> <p>Szerelt - mart konzol Bracket, model 5</p> <p>Íves konzol Bracket, model 6</p> <p>Mart konzol Bracket, model 7</p>	<p>17 x 24</p> <p>22 x 28</p> <p>27 x 34</p> <p>12 x 15</p> <p>15 x 20</p> <p>17 x 22</p> <p>25 x 30</p> <p>21 x 24</p> <p>23 x 28</p> <p>20 x 20</p> <p>25 x 25</p> <p>30 x 30</p> <p>12 x 18</p> <p>16 x 23</p> <p>12 x 15</p> <p>12 x 20</p> <p>12 x 25</p> <p>13 x 16</p> <p>16 x 19</p> <p>19 x 22</p>	<p>10</p> <p>10</p> <p>10</p> <p>10</p> <p>10</p> <p>10</p> <p>10</p> <p>10</p> <p>10</p> <p>10</p> <p>10</p> <p>10</p> <p>10</p> <p>10</p> <p>10</p> <p>10</p> <p>10</p> <p>10</p>	<p>5996025075176</p> <p>5996025075220</p> <p>5996025075275</p> <p>5996025040327</p> <p>5996025040334</p> <p>5996025040341</p> <p>5996025040365</p> <p>5996025040563</p> <p>5996025040570</p> <p>5996025040266</p> <p>5996025040273</p> <p>5996025040280</p> <p>5996025040600</p> <p>5996025040617</p> <p>5996025040426</p> <p>5996025040433</p> <p>5996025040440</p> <p>5996025040648</p> <p>5996025040655</p> <p>5996025040662</p>	<p>1906000</p> <p>1906001</p> <p>1906002</p> <p>1906010</p> <p>1906011</p> <p>1906012</p> <p>1906014</p> <p>1906020</p> <p>1906021</p> <p>1906030</p> <p>1906031</p> <p>1906032</p> <p>1906040</p> <p>1906041</p> <p>1906050</p> <p>1906051</p> <p>1906052</p> <p>1906060</p> <p>1906061</p> <p>1906062</p>	

## Termékcsoport / Product range

3.12

Aqua® Üvegpalcok  
Aqua® Glass-shelves



Üvegpalc, két íves sarokkal  
Glass-shelf with 2 round corners



Íves üvegpalc  
Cambered glass-shelf



Sarok üvegpalc  
Corner glass-self



JÉWÉ megnevezés JÉWÉ product name	Méret Size (cm)	Megrend. egység Order unit	JÉWÉ kód - EAN kód / JÉWÉ code - EAN code			
			SZÍNTELEN FLOAT		HOMOKFÚVOTT DEAD WHITE	
Üvegpalc, két íves sarokkal Glass-shelf with 2 round corners	60 x 15	1	<b>1905002</b>	5996025040815		
	60 x 20	1	<b>1905003</b>	5996025051033		
Íves üvegpalc Cambered glass-shelf	40 x 15	1	<b>1905050</b>	5996025051057	<b>1905080</b>	5996025046268
	60 x 15	1	<b>1905052</b>	5996025051064	<b>1905082</b>	5996025046275
	60 x 20	1	<b>1905053</b>	5996025051095		
Sarok üvegpalc Corner glass-self	25 x 25	1	<b>1905100</b>	5996025050975	<b>1905106</b>	5996025046183
	30 x 30	1	<b>1905101</b>	5996025050982	<b>1905107</b>	5996025046190
6mm-es üveglapok, fóliába csomagolva, műanyag sarokvédővel ellátva Glass boards, thickness 6 mm, packed in foil, equipped with plastic corner caps						

## Termékcsoport / Product range

3.13

### Polc- és üvegpolc tartók Shelf and glass-shelf brackets



„Alpha small” polctartó / „Alpha small” shelf bracket





„Alpha medium” polctartó / „Alpha small” shelf bracket



„Vero rondo”

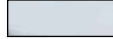

„Vero quatro”

JÉWÉ megnevezés JÉWÉ product name	Méret (cm) sz./mag./m. Size (cm) (w./h./d.)	Megrend. egység Order unit	JÉWÉ kód - EAN kód / JÉWÉ code - EAN code			
			FEHÉR WHITE	ALU ALU	KRÓM CHROME	ARANY / GOLD
<p>„Alpha small” polctartó „Alpha small” shelf bracket</p> <p>4-16 mm vastag polclapokhoz Teherbírás: 15 kg Can be used with 4-16 mm shelves Carrying capacity: 15 kg</p>	2,5 x 6 x 3,5	6	 <b>1907000</b> 8711283310817	 <b>1907001</b> 8711283310831		
<p>„Alpha medium” polctartó „Alpha medium” shelf bracket</p> <p>4-20 mm vastag polclapokhoz Teherbírás: 25 kg Can be used with 4-20 mm shelves Carrying capacity: 25 kg</p>	4 x 6 x 5	6	<b>1907010</b> 8711283098234	<b>1907011</b> 8711283098555	<b>1907012</b> 8711283098531	<b>1907014</b> 8711283098753
<p>„Vero rondo” üvegpolctartó „Vero rondo” glass-shelf bracket</p>	5 x 1,6 x 2,8	6			<b>1907072</b> 8711283329185	
<p>„Vero quatro” üvegpolctartó „Vero quatro” glass-shelf bracket</p> <p>4-10 mm vastag polclapokhoz Teherbírás: 10 kg Can be used with 4-10 mm shelves Carrying capacity: 10 kg</p> <p>A fenti polctartók párosával csomagolva Wrapped per 2 pieces</p>	5 x 1,6 x 2,8	6		<b>1907081</b> 8711283329222	<b>1907082</b> 8711283329215	

# JÉWE

4

**KISBÚTOROK, ÁLLÓPOLCOK  
KIT FURNITURE**



## Termékcsoport / Product range

4.01

### Fadobozok és előszoba tartozékok Wooden boxes and hall accessories



Fadoboz tető nélkül  
Wooden box without lid



Fadoboz tetővel  
Wooden box with lid



Bükk fogasok  
Coatracks beech



Előszobafal  
Coat rack



3 polcos cipőtartó  
Shoe rack with 3 shelves

JÉWÉ megnevezés JÉWÉ product name	Méret (cm) (szél./mag./mély.) Size (cm) (width/height/depth)	Megrend. egység Order unit	EAN kód EAN code	JÉWÉ kód JÉWÉ code
Fadoboz tető nélkül Wooden box without lid	30 x 20 x 15	3	5906210008018	<b>2305000</b>
	40 x 30 x 15	3	5906210008025	<b>2305001</b>
	Nyers fenyő Natural pine	60 x 40 x 15	1	5996025051286
Fadoboz tetővel Wooden box with lid	30 x 20 x 15	3	5906210008056	<b>2305010</b>
	40 x 30 x 15	3	5996025052412	<b>2305011</b>
	Nyers fenyő Natural pine	60 x 40 x 15	1	5996025051309
Előszobafal Coat rack	40 x 80 x 2	1	5996025042963	<b>2503000</b>
Nyers fenyő fóliába csomagolva Natural pine, packed in foil				
2 polcos cipőtartó Shoe rack with 2 shelves	80 x 30 x 25	1	5996025053044	<b>2503010</b>
3 polcos cipőtartó Shoe rack with 3 shelves	80 x 49 x 25	1	5996025053051	<b>2503011</b>
Nyers fenyő fóliába csomagolva szerezési egységcsomaggal Natural pine, packed in foil, with accessories				
3-as fogas	29.5 x 4.5 x 8	1	5996025049931	<b>2503020</b>
4-es fogas	40 x 4.5 x 8	1	5996025049948	<b>2503021</b>
5-ös fogas	50 x 4.5 x 8	1	5996025049955	<b>2503022</b>
6-os fogas	60 x 4.5 x 8	1	5996025049962	<b>2503023</b>
Lakozott bükk alapanyagból, fóliába csomagolva Varnished beech, packed in foil				

## Termékcsoport / Product range

4.02

### Ülőkék Stools



Nagy fenyő sámlí  
Big pine stool



Kis fenyő sámlí  
Small pine stool



Fenyő ülőke fiókkal  
Pine seat with drawer



Háttámlás szék  
Back-rest chair



Bükk hokedli  
Beech stool



Fenyő ülőke  
Pine stool



Összecsukható műanyag fellépő  
Plastic folding stool with step



Összecsukható műanyag sámlí / Plastic folding stool

JEWÉ megnevezés JEWÉ product name	Méret (cm) (szél./mag./mély.) Size (cm) (width/height/depth)	Megrend. egység Order unit	EAN kód EAN code	JEWÉ kód JEWÉ code
Nagy fenyő sámlí Big pine stool	40 x 19 x 25	1	5996025050609	<b>2501001</b>
Kis fenyő sámlí Small pine stool	30 x 14 x 20	1	5996025050593	<b>2501000</b>
Lakkozott fenyő, fóliába csomagolva Varnished pine, packed in foil				
Fenyő ülőke fiókkal Pine seat with drawer	28 x 30 x 28	1	5996025047333	<b>2501050</b>
Lakkozott fenyő, fóliába csomagolva Varnished pine, packed in foil				
Bükk hokedli Beech stool	30 x 46 x 30	1	5996025043199	<b>2501030</b>
Lakkozott bükk, fóliába csomagolva Varnished beech, packed in foil				
Fenyő ülőke Pine stool	29 x 44,5 x 29	1	5996025050616	<b>2501040</b>
Lakkozott fenyő, fóliába csomagolva Varnished pine, packed in foil				
Háttámlás szék Back-rest chair	33 x 67 x 31	1	5996025051446	<b>2501060</b>
Lakkozott fenyő, fóliába csomagolva Varnished pine wood packed in foil				
Összecsukható műanyag sámlí Plastic folding stool				
Fehér / White	21 x 25 x 21	12	5996025051439	<b>2502000</b>
Zöld / Green	21 x 25 x 21	12	5996025051330	<b>2502001</b>
Barna / Brown	21 x 25 x 21	12	5996025051347	<b>2502002</b>
Kék / Blue	21 x 25 x 21	12	5996025051477	<b>2502003</b>
Lila / Violet	21 x 25 x 21	12	5996025051484	<b>2502004</b>
Tömör műanyag, fóliába csomagolva Teherbírás: 100 kg Solid plastic. packed in foil Carrying capacity: 100 kg				
Összecsukható műanyag fellépő Plastic folding stool with step	33 x 67 x 31	6	5996025051460	<b>2502030</b>
Tömör műanyag, fóliába csomagolva Teherbírás: 100 kg Solid plastic. packed in foil Carrying capacity: 100 kg				

## Termékcsoport / Product range

4.03

### Háztartási polcok Household racks

Kicsi háztartási polc 4-es  
Small household 4 rack rack



Nagy háztartási polc 4-es  
Big household rack - 4



Háztartási polc 5-ös  
Household rack - 5



Háztartási polc kombinált  
Household rack - combi

JÉWÉ megnevezés JÉWÉ product name	Méret (cm) (szél./mag./mély.) Size (cm) (width/height/depth)	Megrend. egység Order unit	EAN kód EAN code	JÉWÉ kód JÉWÉ code
Kicsi háztartási polc 4-es Small household rack - 4	70 x 120 x 30	1	5996025043533	<b>2302000</b>
Nagy háztartási polc 4-es Big household rack - 4	70 x 170 x 30	1	5996025043526	<b>2302001</b>
Háztartási polc 5-ös Household rack - 5	70 x 170 x 30	1	5996025048187	<b>2302005</b>
Háztartási polc kombinált Household rack - combi	110 x 170 x 42	1	5996025052511	<b>2302020</b>

Nyers fenyő alapanyagból,  
szerelési egységcsomaggal,  
lapraszerelve fóliába csomagolva  
Lécek vastagsága: 4,2 x 1,8 cm  
Teherbírás: 15 kg/polc

Made of natural pine,  
with accessories, knocked down,  
packed in foil  
Thickness of the slats: 4,2 x 1,8 cm  
Carrying capacity: 15 kg/shelf



## Termékcsoport / Product range

### 4.04

#### Acélpolcok Metal racks



Basic Könnyű fémpolc 4-es fehér  
Basic metal rack - 4, white



Basic Könnyű fémpolc 4-es horganyzott  
Basic metal rack - 4 galvanized



Basic Könnyű fémpolc 5-ös fehér  
Basic metal rack - 5, white



Basic Könnyű fémpolc 6-os fehér  
Basic metal rack - 6, white

JÉWÉ megnevezés JÉWÉ product name	Méret (cm) (szél./mag./mély.) Size (cm) (width/height/depth)	Megrend. egység Order unit	EAN kód EAN code	JÉWÉ kód JÉWÉ code
Basic Könnyű fémpolc 4-es fehér Basic metal rack - 4, white	75 x 150 x 30	1	8586002700961	<b>2301002</b>
Basic Könnyű fémpolc 4-es horganyzott Basic metal rack - 4, galvanized	75 x 150 x 30	1	5996025060141	<b>2301022</b>
Basic Könnyű fémpolc 5-ös fehér Basic metal rack - 5, white	75 x 170 x 30	1	8586002701425	<b>2301005</b>
Basic Könnyű fémpolc 5-ös horganyzott Basic metal rack - 5, galvanized	75 x 170 x 30	1	5996025060158	<b>2301025</b>
Basic Könnyű fémpolc 6-os fehér Basic metal rack - 6, white	75 x 199 x 30	1	5996025060134	<b>2301007</b>
Lapra szerelve, fóliába csomagolva Knocked down, packed in foil				

## Termékcsoport / Product range

4.05

Zsalus ajtók  
Louvre doors



JÉWÉ megnevezés JÉWÉ product name	Méret (cm) (szél./mag./mély.) Size (cm) (width/height/depth)	Megrend. egység Order unit	EAN kód EAN code	JÉWÉ kód JÉWÉ code
Natúr fenyő zsalus ajtók Natural pine louvre doors	38 x 45,7	2	8711283060286	<b>2509000</b>
	38 x 61	2	8711283060293	<b>2509001</b>
	38 x 76,2	2	8711283060309	<b>2509002</b>
	38 x 91,4	2	8711283064369	<b>2509003</b>
	38 x 121,9	2	8711283064376	<b>2509004</b>
	38 x 152,4	2	8711283064383	<b>2509005</b>
	38 x 170	2	8711283060316	<b>2509006</b>
	38 x 198,1	2	8711283060323	<b>2509007</b>
	45 x 45	2	8711283099378	<b>2509010</b>
	45 x 76	2	8711283099385	<b>2509011</b>
	45 x 198	2	8711283099392	<b>2509012</b>
	45 x 237	2	8711283099408	<b>2509013</b>
	30 x 45	2	8711283099347	<b>2509030</b>
	30 x 76	2	8711283099354	<b>2509031</b>
30 x 198	2	8711283099361	<b>2509032</b>	
Fehér zsalus ajtók White louvre doors	38 x 76	2	8711283065434	<b>2509100</b>
	38 x 91	2	8711283065441	<b>2509101</b>
	38 x 122	2	8711283065458	<b>2509102</b>
	38 x 152	2	8711283065465	<b>2509103</b>
	38 x 198	2	8711283060330	<b>2509104</b>

# JÉWE

**Barkan**  
mounting systems

5

**FALI TV- ÉS EGYÉB KÉSZÜLÉKTARTÓK  
WALL MOUNTS**



## Termékcsoport / Product range

### 5.01

#### LCD TV tartók LCD TV wall mounts



Distance from wall  
Távolság a faltól

Side View  
Oldalnézet

**E20** LCD tv tartó, fix  
LCD tv mount fix 37"/94 cm

**21 H** LCD tv tartó 1 funkció  
LCD tv mount 1 functions 37"/94 cm



Distance from wall  
Távolság a faltól

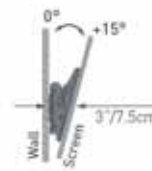

Side View  
Oldalnézet

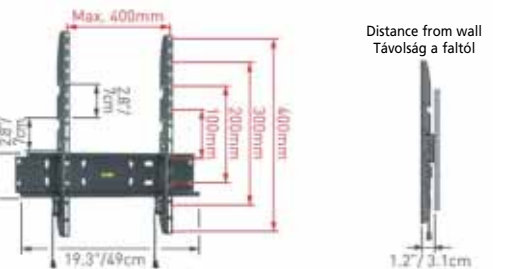

Distance from wall  
Távolság a faltól

Side View / Oldalnézet

**E30** LCD tv tartó, fix  
LCD tv mount fix 56"/142 cm

**31 H** LCD tv tartó 1 funkció  
LCD tv mount 1 functions 56"/142 cm



Distance from wall  
Távolság a faltól



Side View  
Oldalnézet

JÉWÉ megnevezés JÉWÉ product name	Teherbírás (kg) Carrying capacity (kg)	Megrend. egység Order unit	EAN kód EAN code	JÉWÉ kód JÉWÉ code
<b>E20</b> LCD tv tartó, fix LCD tv mount fix	40	1	7290003975969	<b>2911000</b>
<b>21 H</b> LCD tv tartó 1 funkció LCD tv mount 1 functions	40	1	7290003975914	<b>2911001</b>
<b>E30</b> LCD tv tartó, fix LCD tv mount fix	50	1	7290004574208	<b>2912000</b>
<b>31 H</b> LCD tv tartó 1 funkció LCD tv mount 1 functions	50	1	7290003975983	<b>2912001</b>

## Termékcsoport / Product range

### 5.01

#### LCD TV tartók LCD TV wall mounts



Distance from wall  
Távolság a faltól  
Top View  
Felülnézet

**E220** LCD tv tartó 2 funkció  
LCD tv mount 2 functions

Max TV  
37"/94 cm  
30kg  
50lbs  
Max

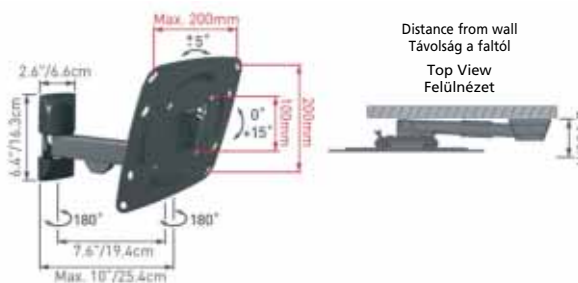

Distance from wall  
Távolság a faltól  
Top View  
Felülnézet

**E230** LCD tv tartó 3 funkció  
LCD tv mount 3 functions



Max TV  
37"/94 cm  
25kg  
55lbs  
Max



Distance from wall  
Távolság a faltól  
Top View  
Felülnézet

**E240** LCD tv tartó 4 funkció  
LCD tv mount 4 functions

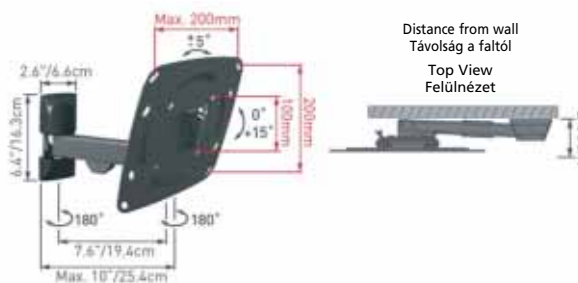
Max TV  
37"/94 cm  
25kg  
55lbs  
Max

Termékcsoport / Product range	JÉWÉ megnevezés JÉWÉ product name	Teherbírás (kg) Carrying capacity (kg)	Megrend. egység Order unit	EAN kód EAN code	JÉWÉ kód JÉWÉ code
<b>E220</b> LCD tv tartó 2 funkció LCD tv mount 2 functions 	<b>E220</b> LCD tv tartó 2 funkció LCD tv mount 2 functions	30	1	7290004574185	<b>2910220</b>
<b>E230</b> LCD tv tartó 3 funkció LCD tv mount 3 functions 	<b>E230</b> LCD tv tartó 3 funkció LCD tv mount 3 functions	25	1	7290004574284	<b>2910230</b>
<b>E240</b> LCD tv tartó 4 funkció LCD tv mount 4 functions 	<b>E240</b> LCD tv tartó 4 funkció LCD tv mount 4 functions	25	1	7290004574321	<b>2910240</b>

## Termékcsoport / Product range

### 5.01

#### LCD TV tartók LCD TV wall mounts

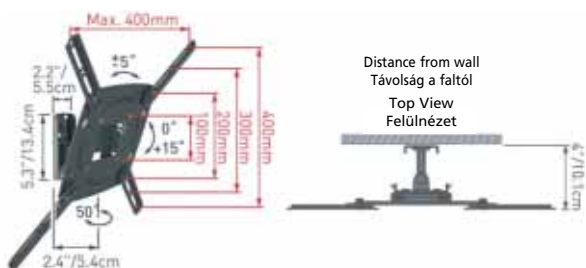

Distance from wall  
Távolság a faltól  
Top View  
Felülnézet

**E320** LCD tv tartó 2 funkció  
LCD tv mount 2 functions

Max TV  
30kg  
50lbs  
Max

56"/142 cm

**E330** LCD tv tartó 3 funkció  
LCD tv mount 3 functions

Max TV  
30kg  
50lbs  
Max

56"/142 cm

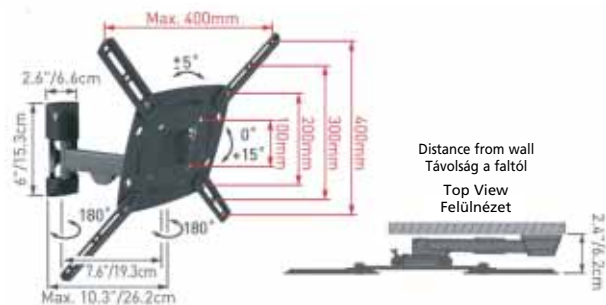

Distance from wall  
Távolság a faltól  
Top View  
Felülnézet

**E330**

LCD tv tartó 3 funkció  
LCD tv mount 3 functions

30

1

7290004574741

**2910330**

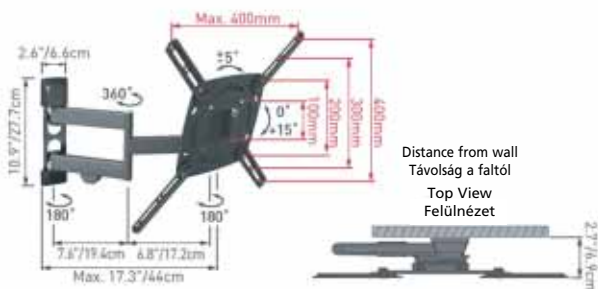

Distance from wall  
Távolság a faltól  
Top View  
Felülnézet

**E340** LCD tv tartó 4 funkció  
LCD tv mount 4 functions

Max TV  
30kg  
50lbs  
Max

56"/142 cm

**E340**

LCD tv tartó 4 funkció  
LCD tv mount 4 functions

30

1

7290004574772

**2910340**

**Teherbírás (kg)**  
Carrying  
capacity (kg)

**Megrend.**  
egység  
Order  
unit

**EAN kód**  
EAN code

**JÉWÉ kód**  
JÉWÉ code

**E320**

LCD tv tartó 2 funkció  
LCD tv mount 2 functions

30

1

7290004574727

**2910320**

## Termékcsoport / Product range

5.02

### Egyéb készüléktartók Other wall mounts

E80

DVD/vidéo tartó  
DVD/video wall mount

10kg  
25lbs  
Max



E80

DVD/vidéo tartó  
DVD/video wall mount

10

1

7290004782443

2916000

151

Hangfaltartó szett  
Speaker wall mount set

5kg  
11lbs  
Max



151

Hangfaltartó szett  
Speaker wall mount set

5

1

7290003975068

2917001



Univerzális falitartó  
Universal wall mount

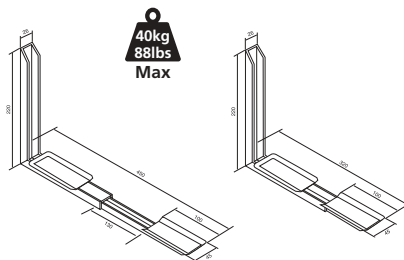

Univerzális falitartó  
Universal wall mount

40

1

5996025050739

2908000

## Termékcsoport / Product range

### 5.03

#### Univerzális telefon és GPS tartó Universal car mount

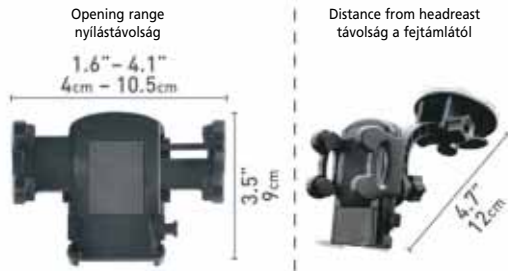

**M10** Univerzális készüléktartó autóba  
Universal car mount

JÉWÉ megnevezés JÉWÉ product name	Méret (cm) (szél./mag./mély.) Size (cm) (width/height/depth)	Megrend. egység Order unit	EAN kód EAN code	JÉWÉ kód JÉWÉ code
<b>M10</b> Univerzális készüléktartó autóba Universal car mount	10,5 x 9 x 12	1	7290004782122	<b>2916010</b>

### 5.04

#### Tablettartó Universal mount



**T30** Tablettartó ülésre  
Headrest universal car mount

<b>T30</b> Tablettartó ülésre Headrest universal car mount	21 x 22 x 15	1	7290004782153	<b>2916013</b>
--	--------------	---	---------------	----------------

**T31** Tablettartó autóba  
Universal car mount for tablet

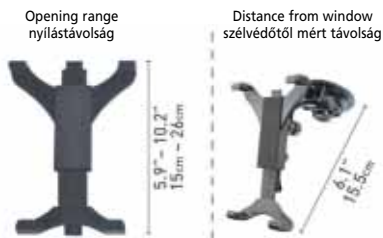

<b>T31</b> Tablettartó autóba Universal car mount for tablet	14,5 x 26 x 15,5	1	7290004782160	<b>2916014</b>
--	------------------	---	---------------	----------------



**T41** Tablettartó  
Foldable stand for tablet & smartphone

<b>T41</b> Tablettartó Foldable stand for tablet & smartphone	10 x 15 x ~12	1	7290004782184	<b>2916016</b>
---	---------------	---	---------------	----------------



# JÉWÉ

6

**EGYÉB TERMÉKEK**  
**OTHER PRODUCTS**



## Termékcsoport / Product range

6.01

Fa kerítéselemek  
Wooden fence elements



„Barokk” fenyő keríteselem  
„Barokk” pine fence element

JÉWÉ megnevezés JÉWÉ product name	Méret (cm) Size (cm)	Megrend. egység Order unit	EAN kód EAN code	JÉWÉ kód JÉWÉ code
„Barokk” fenyő keríteselem „Barokk” pine fence element	9 x 80 x 1.8	10	5996025051620	<b>2711010</b>
	9 x 100 x 1.8	10	5996025051637	<b>2711011</b>
	9 x 120 x 1.8	10	5996025040051	<b>2711012</b>

## Termékcsoport / Product range

6.02

### Fa korlátelelemek Wooden baluster elements



JÉWÉ megnevezés JÉWÉ product name	Méret (cm) (szél./mag./mély.) Size (cm) (width/height/depth)	Megrend. egység Order unit	JÉWÉ kód - EAN kód / JÉWÉ code - EAN code	
			BÜKK BEECH	
Kezdő korlátelelem TIP1 Newel balustrade TIP1	5,5 x 107 x 5,5	1	5996025047364	<b>2702001</b>
Közbenő korlátelelem TIP1 Intermediary balustrade TIP1	4,5 x 90 x 4,5	9	5996025047340	<b>2702000</b>
Kezdő korlátelelem TIP2 Newel balustrade TIP2	5,5 x 107 x 5,5	1	5996025047470	<b>2702011</b>
Közbenő korlátelelem TIP2 Intermediary balustrade TIP2	5,5 x 107 x 5,5	9	5996025047463	<b>2702010</b>
Kezdő korlátelelem TIP3 Newel balustrade TIP3	5,5 x 107 x 5,5	1	5996025014205	<b>2702021</b>
Közbenő korlátelelem TIP3 Intermediary balustrade TIP3	5,5 x 107 x 5,5	9	5996025013505	<b>2702020</b>
Felső kapaszkodó (omega) Handrail (omega)	5,5 x 4 x 240	1	5996025047371	<b>2702102</b>
	5,5 x 4 x 160	1	5996025047890	<b>2702100</b>
Alsó gyűjtő (téglalap) Under rail	5,5 x 2 x 240	1	5996025047388	<b>2702112</b>
	5,5 x 2 x 160	1	5996025048965	<b>2702110</b>

## Termékcsoport / Product range

6.03

Solide® kapaszkodó rendszer  
Solide® handrail system



Alu kapaszkodó, kerek  
Aluminium anodised handrail, round



Fenyő kapaszkodó, kerek  
Solid pine handrail, round



Bükk kapaszkodó, kerek  
Beech handrail, round



Egztófa kapaszkodó, kerek  
Dark hardwood handrail, round



JÉWÉ megnevezés  
JÉWÉ product name

Méret (cm)  
Size (cm)

Megrend.  
egység  
Order unit

JÉWÉ kód - EAN kód / JÉWÉ code - EAN code

100 cm

270 cm

 Alu kapaszkodó, kerek  
Aluminium anodised handrail, round

Ø 4,5

3

**2707000**  
8711283328607

**2707030**  
8711283328614

Alumínium alapanyag, fóliába csomagolva  
Made of aluminium, packed in foil

 Fenyő kapaszkodó, kerek  
Solid pine handrail, round

Ø 4,5

3

**2707010**  
8711283328508

**2707040**  
8711283328522

 Bükk kapaszkodó, kerek  
Beech handrail, round

Ø 4,5

3

**2707011**  
8711283369839

**2707041**  
8711283369846

 Egztófa kapaszkodó, kerek  
Dark hardwood handrail, round

Ø 4,5

3

**2707012**  
8711283328546

**2707042**  
8711283328553

Tömörfa alapanyag, fóliába csomagolva  
Made of solid wood, packed in foil

## Termékcsoport / Product range

6.03

### Solide® kapaszkodó rendszer Solide® handrail system



Kapaszkodó tartó Helsinki  
Handrail bracket Helsinki



Végzáró, sima  
Handrail endcap, even



Kapaszkodó tartó Oslo  
Handrail bracket Oslo





Végzáró O45 sima  
flexibilis sarok O45  
flexible corner O45



Kapaszkodó tartó New York  
Handrail bracket New York rvs



Flexibilis Sarok  
Flexible corner connection

JÉWÉ megnevezés JÉWÉ product name	Méret (cm) Size (cm)	Megrend. egység Order unit	JÉWÉ kód - EAN kód / JÉWÉ code - EAN code	
			ALUMINIUM	INOX
Kapaszkodó tartó Helsinki Handrail bracket Helsinki	8 x 6,5 Ø	4	 <b>2708030</b> 8711283404073	
Kapaszkodó tartó Oslo Handrail bracket Oslo	8 x 6,5 Ø	4	<b>2708040</b> 8711283404103	
Kapaszkodó tartó New York Handrail bracket New York rvs	8 x 6,5 Ø	4		<b>2708051</b> 8711283404752
Párosával csomagolva 2 pieces per blister				
Végzáró O45 sima Endcap O45 alu flat	Ø 4,5	6	<b>2709004</b> 8711283405087	
Végzáró O45 sima Round handrail endcap, convex	Ø 4,5	6		<b>2709005</b> 8711283405094
Párosával csomagolva 2 pieces per blister				
Flexibilis sarok O45 flexible corner O45	Ø 4,5	4	<b>2709050</b> 8711283405131	<b>2709051</b> 8711283405124
Egyesével csomagolva 1 piece per blister				

## Termékcsoport / Product range

6.04

### Küszöbök és lépcsőlapok Door-steps and stair parts



Bükk lépcsőlapok  
Beech stair parts

Bükk küszöbfa  
Beech door-step

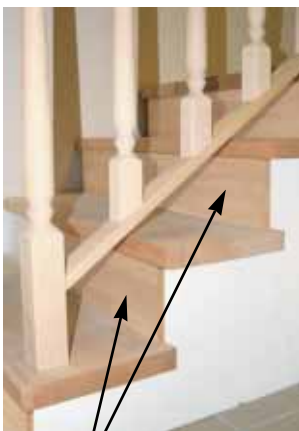

Bükk homloklap  
Beech riser

JÉWÉ megnevezés JÉWÉ product name	Méret (cm) (szél./mag./mély.) Size (cm) (width/height/depth)	Megrend. egység Order unit	EAN kód EAN code	JÉWÉ kód JÉWÉ code
Bükk küszöbfa	7 x 100	10	5996025051927	<b>2710000</b>
Beech door-step	8 x 100	10	5996025051934	<b>2710001</b>
	10 x 100	10	5996025051941	<b>2710002</b>
	12 x 100	10	5996025051958	<b>2710003</b>
Bükk lépcsőlap	90 x 2,8 x 28	1	5996025051828	<b>2701000</b>
Beech stair parts	110 x 2,8 x 28	1	5996025051835	<b>2701001</b>
	90 x 4 x 28	1	5996025051842	<b>2701002</b>
	110 x 4 x 28	1	5996025051859	<b>2701003</b>
Bükk lépcsőlap, C/C	80 x 2,8 x 28	1	5996025060004	<b>2701009</b>
Beech stair parts, C/C	90 x 2,8 x 28	1	5996025040136	<b>2701010</b>
	110 x 2,8 x 28	1	5996025040143	<b>2701011</b>
	90 x 4 x 28	1	5996025040150	<b>2701012</b>
	110 x 4 x 28	1	5996025040167	<b>2701013</b>
Álgeszt (színelterés) előfordulhat Colour variance can happen				
Bükk homloklap	90 x 1,8 x 20	1	5996025013307	<b>2701030</b>
Beech riser	110 x 1,8 x 20	1	5996025013406	<b>2701031</b>

## Termékcsoport / Product range

6.05

### Boros polcok, palacktároló rendszerek Wine racks

Boros polc, 20 üveges  
20 bottle wine rack

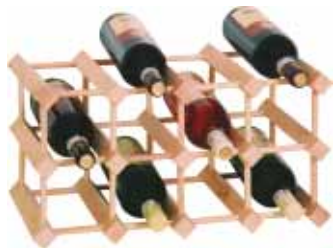

Palacktároló alapsomag,  
négyzetű  
Solid wood wine rack,  
square



Palacktároló oszlop  
Wine rack column

Palacktároló stift 10 db-os  
Wine rack dowel, 10 pieces



Boros polc, 56 üveges  
56 bottle wine rack



JÉWÉ megnevezés  
JÉWÉ product name

Méret (cm)  
(szél./mag./mély.)  
Size (cm)  
(width/height/depth)

Megrend.  
egység  
Order  
unit

EAN kód  
EAN code

JÉWÉ kód  
JÉWÉ code

Fenyő boros polc, 20 üveges  
20 bottle wine rack, pine

47 x 70 x 26

1

5996025048156

**2306000**

Fenyő boros polc, 56 üveges  
56 bottle wine rack, pine

84 x 120 x 26

1

5996025048163

**2306001**

Nyers tömörfa alapanyagból,  
szerelési egységcsomaggal,  
lapraszerelve, fóliába csomagolva  
Natural whitewood, with accessories,  
knocked down, packed in foil

Palacktároló alapsomag,  
négyzetű  
Solid wood wine rack, square

50 x 27 x 27

1

5996025046343

**2306040**

Nyers bükk oszlop + nyers bükk stift  
12 palackhoz, bővíthető  
Natural beech column + natural  
beech stick, for 12 bottles, can be  
expand

Palacktároló oszlop  
Wine rack column

27

1

5996025042406

**2306041**

Nyers bükk oszlop  
kartondobozba csomagolva  
Natural beech column  
Packed in carton

Palacktároló stift 10 db-os  
Wine rack dowel, 10 pieces

9

1

5996025042420

**2306042**

10 db nyers bükk hornyolt tipli  
fóliába csomagolva  
10 pieces of beech dowels,  
packed in foil

## Termékcsoport / Product range

6.06

### HKC teraszpadló HKC garden decking



Szélprofil  
Border profile

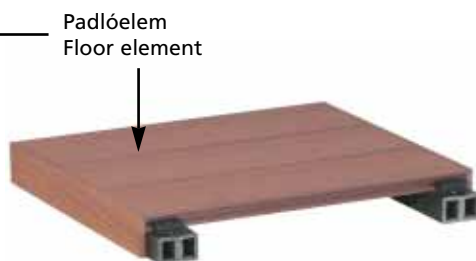



Padlóelem  
Floor element



Alsó rögzítő profil  
Under profile



Rögzítő kapcsok és csavarok  
Fixing clips and screws

JÉWÉ megnevezés JÉWÉ product name	Méret (cm) (hossz./szél./mag.) Size (cm) (length/width/high)	Megrend. egység Order unit	EAN kód EAN code	JÉWÉ kód JÉWÉ code
 Barna egyoldalas padlóelem 3 db/csomag Brown floor element 3 pcs/pack	220 x 15 x 2,5	1	8711615148088	<b>3101000</b>
Barna szélprofil Brown border profile	220 x 6,3 x 1	6	8711615140983	<b>3101010</b>
 Szürke egyoldalas padlóelem 3 db/csomag Anthracite floor element 3 pcs/pack	220 x 15 x 2,5	1	8711615148033	<b>3101001</b>
Szürke szélprofil Anthracite border profile	220 x 6,3 x 1	6	8711615140976	<b>3101011</b>
Alsó rögzítő profil Under profile	220 x 6 x 4	3	8711283341675	<b>3101020</b>
Rögzítő kapcsok és csavarok 55 db/csomag Fixing clips and screws 55 pcs/pack		1	8711283361130	<b>3101030</b>
Fa és műanyag keverékéből előállított alapanyag, ezáltal időjárás-, víz- és UV-álló, felületkezelést nem igényel. A termék forgács-, repedés- és csúszásmentes. A padlóelem két oldala különböző felületű.		HKC is made of wood and plastic compound, hence it is weather, water and UV resistant, surface handling is not necessary. This product is splinter, split and slide free. Floor elements have got a fine profile on one side and a wide profile on the other side.		
1 m <sup>2</sup> padlóhoz szükséges: - 1 csomag padlóelem (3 db) - alsó rögzítő profil 40 cm-enként - 16 db rögzítő kapocs - szélprofilok		For 1 square meter floor: - 1 package of floor unit (3 pieces) - Under profile per 40 centimeter - 16 pieces of fixing clip - border profiles		



## Termékcsoport / Product range

6.07

### Ruhaszárító Clothes dryer rack



Ruhaszárító hengeres korláthoz PKS01  
Clothes dryer rack PKS01



Ruhaszárító szögletes korláthoz PKS02  
Clothes dryer rack PKS02



Ruhaszárító falra szerelhető PKS03  
Clothes dryer rack PKS03

JÉWÉ megnevezés  
JÉWÉ product name

Méret (cm)  
(hossz./szél./mag.)  
Size (cm)  
(length/width/high)

Megrend.  
egység  
Order  
unit

EAN kód  
EAN code

JÉWÉ kód  
JÉWÉ code

Ruhaszárító hengeres korláthoz PKS01  
Clothes dryer rack PKS01

56 x 8 x 8

6

5996025060226

3308000

Ruhaszárító szögletes korláthoz PKS02  
Clothes dryer rack PKS02

56 x 8 x 8

6

5996025060233

3308001

Ruhaszárító falra szerelhető PKS03  
Clothes dryer rack PKS03

54 x 9 x 9

6

5996025060240

3308002

A csomag tartalma:  
- 2 db alumínium kar a megfelelő rögzítő fejjel  
- 12 m erős ruhaszárító kötél  
- 12 db műanyag csipesz  
- 1 db imbuszkulcs

6.08

### Védőrácsok Stairgates

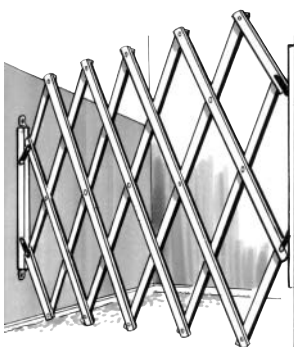

Natúr védőrács  
Natur gate

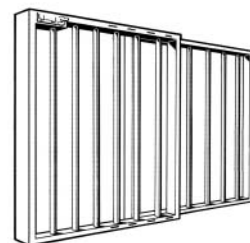

Peti védőrács  
Peti baby guard rail



Védőrács LUCAS  
Stairgate LUCAS

Natúr védőrács  
Natur gate  
Fóliába csomagolva  
Packed in foil

17-90 x 75

5996025040259

2507000

Peti védőrács  
Peti baby guard rail  
Kartonba csomagolva  
Packed in carton

75-105 x 80

5996025058919

2507010

Védőrács LUCAS  
Stairgate LUCAS  
Kartonba csomagolva  
Packed in carton

79 - 113 x 75

8711283382722

2507030

## Termékcsoport / Product range

6.09

Egyéb termékek  
Other products



Műanyag térkősablon  
Concrete-template



Fabak  
Wooden trestle



Parketta lerakó szett  
Installation kit for laminate flooring



Műanyag ék  
Plastic chocks



Műanyag szék alátétlap  
Chair mat

JÉWÉ megnevezés JÉWÉ product name	Méret (cm) (hossz./szél./mag.) Size (cm) (length/width/high)	Megrend. egység Order unit	EAN kód EAN code	JÉWÉ kód JÉWÉ code
Műanyag térkősablon Concrete-template	55 x 55 x 5,5	1	5998742710002	<b>3303000</b>
Bükk fabak Beech trestle Natúr bükk alapanyagból Made of natural beech	75 x 75	1	5996025040259	<b>2307000</b>
Univerzális parketta lerakó szett Installation kit for laminate flooring Műanyag bliszterbe csomagolva Blister package  tartalma: 1 db feszítő vas, 1 db beütő tuskó, 40 db műanyag ék 1 strecher, 1 plastic block, 40 wedges		1	5996025051002	<b>1412000</b>
Műanyag ék Plastic chocks Műanyag bliszterbe csomagolva, 20 db/csomag Blister package, 20 pieces/pack	3 x 0,6 x 6	1	5996025053013	<b>1412001</b>
Műanyag szék alátétlap Chair mat	122 x 92	1	7290010027606	<b>3304000</b>

## Termékcsoport / Product range

6.09

### Egyéb termékek Other products



Bükk faék, vegyes csomag

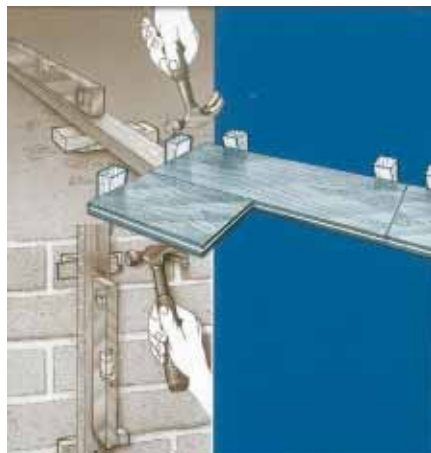

Bükk faék  
Beech wedge,



Ajtó-ablak fenyő ék



Ajtó-ablak fenyő ék  
28 mm 10 db/csom  
Door-window pine wedge,  
28 mm thick, 10 pcs/pack

JÉWÉ megnevezés JÉWÉ product name	Méret (mm) (hossz./szél./mag.) Size (mm) (length/width/high)	Megrend. egység Order unit	EAN kód EAN code	JÉWÉ kód JÉWÉ code
Bükk faék 1 mm vastag 25 db/csom Beech wedge, 1 mm thick, 25 pcs/pack	80 x 20 x 1	16	8711283028347	<b>1412010</b>
Bükk faék 2 mm vastag 25 db/csom Beech wedge, 2 mm thick, 25 pcs/pack	80 x 20 x 2	16	8711283028354	<b>1412011</b>
Bükk faék 3 mm vastag 25 db/csom Beech wedge, 3 mm thick, 25 pcs/pack	80 x 20 x 3	16	8711283028361	<b>1412012</b>
Bükk faék 4 mm vastag 25 db/csom Beech wedge, 4 mm thick, 25 pcs/pack	80 x 20 x 4	16	8711283028378	<b>1412013</b>
Bükk faék 5 mm vastag 25 db/csom Beech wedge, 5 mm thick, 25 pcs/pack	80 x 20 x 5	16	8711283028385	<b>1412014</b>
Bükk faék vegyes csomag 1-5 mm vastag 10 db/méret Beech wedge pack mixed, 1-5 mm thick, 10 pcs/size	80 x 20 x 1-5	16	8711283028392	<b>1412015</b>
Faék keményfa csomag 15 mm vastag 32 db/csom Hardwood wedge pack, 15 mm thick 32 pcs/pack	96 x 18 x 15	8	8711283051475	<b>1412016</b>
Ajtó-ablak fenyő ék 28 mm 10 db/csom Door-window pine wedge, 28 mm thick, 10 pcs/pack	148 x 44 x 30	16	8711283028408	<b>1412017</b>

## Termékcsoport / Product range

6.10

### Alkohol desztilláló készülékek Distiller boilers



30 l-es készülék keverővel  
30 l distiller boiler with mixer



60-80-100 l-es készülékek  
60-80-100 l distiller boilers



Gyümölcsdaráló  
Fruit grinder

JÉWÉ megnevezés JÉWÉ product name	Méret (cm) (hossz./szél./mag.) Size (cm) (length/width/high)	Megrend. egység Order unit	EAN kód EAN code	JÉWÉ kód JÉWÉ code
30 l-es készülék keverővel 30 l distiller boiler with mixer	115 x 48 x 75	1	8606105652063	<b>3301001</b>
60 l-es készülék, keverő nélkül 60 l distiller boiler	220 x 65 x 157	1	8606105652070	<b>3301010</b>
80 l-es készülék keverő nélkül 80 l distiller boiler	228 x 73 x 157	1	8606105652087	<b>3301020</b>
80 l-es készülék, keverővel 80 l distiller boiler with mixer	228 x 73 x 157	1	8606105652100	<b>3301021</b>
100 l-es készülék, keverő nélkül 100 l distiller boiler	228 x 73 x 157	1	8606105652094	<b>3301030</b>
100 l-es készülék, keverővel 100 l distiller boiler with mixer	228 x 73 x 157	1	8606105652117	<b>3301031</b>
Gyümölcsdaráló Fruit grinder	~ 65 x 40 x 36	1	8606105652209	<b>3301050</b>

# JÉWE

**CanDo®**

7

**NYÍLÁSZÁRÓK**

**DOORS AND WINDOWS**



## Termékcsoport / Product range

### 7.01

#### PVC mellékbejárati ajtók PVC white side-door

ECO modellek / models



Dráva

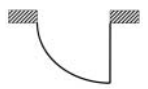

ECO 2

JÉWÉ megnevezés JÉWÉ product name	Méret (cm) (szél./mag.) Size (cm) (width/height)	Megrend. egység Order unit	JÉWÉ kód - EAN kód / JÉWÉ code - EAN code	
			BAL LEFT	JOBB RIGHT
Dráva fehér / white	98 x 208	1	 <b>1006000</b> 5996025059244	 <b>1006001</b> 5996025059251
ECO 2 fehér / white	98 x 208	1	<b>1006020</b> 5996025059503	<b>1006021</b> 5996025059510
<ul style="list-style-type: none"> <li>- 60 mm vastag, 3 légkamrás szárnyprofil</li> <li>- 60 mm vastag, 3 légkamrás tokprofil</li> <li>- 5 ponton záródó, kilincs működtetésű zárszerkezet</li> <li>- 4 db fix ajtópánt</li> <li>- A kilincs tartozék!</li> </ul>		<ul style="list-style-type: none"> <li>- 60 mm thick wing profile with 3 chambers</li> <li>- 60 mm thick case profile with 3 chambers</li> <li>- 5 point lock-system</li> <li>- 4 pcs of fix hinges</li> <li>- With door handle!</li> </ul>		
Az ajtó közvetlen kültérre nem nyílhat!		Not to use as exterior door!		

### 7.02

#### CanDo® PVC bejárati ajtók CanDo® PVC front doors

BASIC modellek / models



Sevilla



Barcelona



Salamanca



Rimini

Sevilla fehér / white	98 x 208	1	<b>1001000</b> 5996025055680	<b>1001001</b> 5996025055697
Barcelona fehér / white	98 x 208	1	<b>1001010</b> 5996025055703	<b>1001011</b> 5996025055710
Salamanca fehér / white	98 x 208	1	<b>1001020</b> 5996025055727	<b>1001021</b> 5996025055734
Rimini fehér / white	98 x 208	1	<b>1001030</b> 5949033800490	<b>1001031</b> 5949033800506
Rimini aranytölgy / golden oak	98 x 208	1	<b>1001032</b> 5949033800513	<b>1001033</b> 5949033800520
<ul style="list-style-type: none"> <li>- 70 mm vastag, 5 légkamrás szárnyprofil</li> <li>- 70 mm vastag, 6 légkamrás tokprofil</li> <li>- 5 ponton záródó, kilincs működtetésű zárszerkezet</li> <li>- 3 db, 3 dimenzióban állítható ajtópánt</li> <li>- Állítható zárfogadó vasalat</li> <li>- Hőhidmentes alumínium küszöb</li> <li>- A kilincs tartozék!</li> </ul>		<ul style="list-style-type: none"> <li>- 70 mm thick wing profile with 5 chambers</li> <li>- 70 mm thick case profile with 6 chambers</li> <li>- 5 point lock-system</li> <li>- 3 pcs of hinges adjustable in 3 dimensions</li> <li>- Adjustable strikers</li> <li>- Thermoisolated treshold</li> <li>- With door handle!</li> </ul>		

## Termékcsoport / Product range

7.02

CanDo® PVC bejárati ajtók  
CanDo® PVC front doors

MEDIUM modellek / models



Milano



Torino



Velenice



Firenze

EXCLUSIVE modellek / models



Ibiza



Ibiza



Korzika



Korzika

JÉWÉ megnevezés JÉWÉ product name	Méret (cm) (szél./mag.) Size (cm) (width/height)	Megrend. egység Order unit	JÉWÉ kód - EAN kód / JÉWÉ code - EAN code	
			BAL LEFT	JOBB RIGHT
Milano fehér / white	98 x 208	1	 <b>1002010</b> 5996025055789	 <b>1002011</b> 599602505579
Torino fehér / white	98 x 208	1	<b>1002020</b> 5996025055802	<b>1002021</b> 5996025055819
Velenice fehér / white	98 x 208	1	<b>1002000</b> 5996025055826	<b>1002001</b> 5996025055833
Firenze fehér / white	98 x 208	1	<b>1002030</b> 5996025055765	<b>1002031</b> 5996025055772
Ibiza fehér / white	98 x 208	1	<b>1003000</b> 5996025054829	<b>1003001</b> 5996025054836
Ibiza aranytölgy / golden oak	98 x 208	1	<b>1003006</b> 5996025056083	<b>1003007</b> 5996025056090
Korzika fehér / white	98 x 208	1	<b>1003050</b> 5996025054881	<b>1003051</b> 5996025054898
Korzika aranytölgy / golden oak	98 x 208	1	<b>1003052</b> 5996025056106	<b>1003053</b> 5996025056113

- 70 mm vastag, 5 légkamrás szárnyprofil
- 70 mm vastag, 6 légkamrás tokprofil
- 5 ponton záródó, kilincs működtetésű zárszerkezet
- 3 db, 3 dimenzióban állítható ajtópánt
- Állítható zárfogadó vasalat
- Hőhidmentes alumínium küszöb
- A kilincs tartozék!

- 70 mm thick wing profile with 5 chambers
- 70 mm thick case profile with 6 chambers
- 5 point lock-system
- 3 pcs of hinges adjustable in 3 dimensions
- Adjustable strikers
- Thermoisolated treshold
- With door handle!

## Termékcsoport / Product range

7.02

CanDo® PVC bejárati ajtók  
CanDo® PVC front doors

EXCLUSIVE modellek / models



Ciprus



Málta



Korfu 2



Korfu 8

JÉWÉ megnevezés JÉWÉ product name	Méret (cm) (szél./mag.) Size (cm) (width/height)	Megrend. egység Order unit	JÉWÉ kód - EAN kód / JÉWÉ code - EAN code	
			BAL LEFT	JOBB RIGHT
Ciprus fehér / white	98 x 208	1	 <b>1003020</b> 5996025054867	 <b>1003021</b> 5996025054874
Málta fehér / white	98 x 208	1	<b>1003030</b> 5996025059138	<b>1003031</b> 5996025059145
Korfu 2 fehér Corfu 2 white	98 x 208	1	<b>1003070</b> 5996025060257	<b>1003071</b> 5996025060264
Korfu 8 fehér Corfu 8 white	98 x 208	1	<b>1003074</b> 5996025060271	<b>1003075</b> 5996025060288
<ul style="list-style-type: none"> <li>- 70 mm vastag, 5 légkamrás szárnyprofil</li> <li>- 70 mm vastag, 6 légkamrás tokprofil</li> <li>- 5 ponton záródó, kilincs működtetésű zárszerkezet</li> <li>- 3 db, 3 dimenzióban állítható ajtópánt</li> <li>- Állítható zárfogadó vasalat</li> <li>- Hőhídmentes alumínium küszöb</li> <li>- A kilincs tartozék!</li> </ul>		<ul style="list-style-type: none"> <li>- 70 mm thick wing profile with 5 chambers</li> <li>- 70 mm thick case profile with 6 chambers</li> <li>- 5 point lock-system</li> <li>- 3 pcs of hinges adjustable in 3 dimensions</li> <li>- Adjustable strikers</li> <li>- Thermoisolated treshold</li> <li>- With door handle!</li> </ul>		



## Termékcsoport / Product range

7.02

CanDo® PVC bejárati ajtók  
CanDo® PVC front doors

INOX modellek / models



Alabama





Oregon



Florida

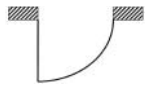

Europa

JÉWÉ megnevezés JÉWÉ product name	Méret (cm) (szél./mag.) Size (cm) (width/height)	Megrend. egység Order unit	JÉWÉ kód - EAN kód / JÉWÉ code - EAN code	
			BAL LEFT	JOBB RIGHT
Alabama fehér / white	98 x 208	1	 <b>1004030</b> 5996025057448	 <b>1004031</b> 5996025057455
Oregon fehér / white	98 x 208	1	<b>1004040</b> 5996025057288	<b>1004041</b> 5996025057295
Florida fehér / white	98 x 208	1	<b>1004050</b> 5996025057462	<b>1004051</b> 5996025057479
Europa fehér / white	98 x 208	1	<b>1004060</b> 5996025060226	<b>1004061</b> 5996025060233
<ul style="list-style-type: none"> <li>- 70 mm vastag, 5 légkamrás szárnyprofil</li> <li>- 70 mm vastag, 6 légkamrás tokprofil</li> <li>- 5 ponton záródó, kilincs működtetésű zárszerkezet</li> <li>- 3 db, 3 dimenzióban állítható ajtópánt</li> <li>- Állítható zárfogadó vasalat</li> <li>- Inox díszítés mindkét oldalon</li> <li>- Hőhídmentes alumínium küszöb</li> <li>- A kilincs tartozék!</li> </ul>		<ul style="list-style-type: none"> <li>- 70 mm thick wing profile with 5 chambers</li> <li>- 70 mm thick case profile with 6 chambers</li> <li>- 5 point lock-system</li> <li>- 3 pcs of hinges adjustable in 3 dimensions</li> <li>- Adjustable strikers</li> <li>- Inox decoration on both sides</li> <li>- Thermoisolated treshold</li> <li>- With door handle!</li> </ul>		

## Termékcsoport / Product range

**7.03**

### PVC ablakok / PVC windows



Bukó-nyíló egyszárnyú ablak  
One wing window, tilt and turn



Bukó-nyíló erkélyajtó  
Balcony door, tilt and turn

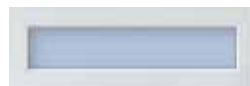

Fix felüvilágító ablak  
Fixed upper window



Fix oldalvilágító ablak  
Fixed window



Kétszárnyú ablak, nyíló / bukó-nyíló  
Two wing window, tilt / tilt and turn



"Economic" bukó pinceablak  
"Economic" cellar window

CanDo DELUXE ablakok  
- 6 kamrás, 70 mm vastag profil  
- 1,1 K értékű Low-E üvegezés  
- Ívelt üvegezőléc  
- Körbefutó szürke gumitömítés  
- Erős acél merevítés  
- Minden ablak bukó-nyíló vasalattal szerelve  
- A kilincs tartozék!

CanDo DELUXE windows  
- 70 mm thick profile with 6 chambers  
- Ug=1,1 Low-E glass  
- Rounded glazing beads  
- Double grey gasket around  
- Strong steel reinforcement  
- Every window with tilt&turn hardware  
- Handle for free!"

4 kamrás ablakok / 4 chamber windows  
- 4 kamrás, 60 mm vastag profil / 60 mm thick profile with 4 chambers  
- 1,1 K értékű Low-E üvegezés / Ug=1,1 Low-E glass  
- Körbefutó szürke gumitömítés  
- Double gregaske around  
- Erős acél merevítés / Strong steel reinforcement  
- Minden ablak bukó-nyíló vasalattal szerelve  
- Every window with tilt&turn hardware  
- A kilincs tartozék! / Handle for free!"

JÉWÉ megnevezés JÉWÉ product name	Méret (cm) (szél./mag.) Size (cm) (width/height)	Megrend. egység Order unit	JÉWÉ kód - EAN kód / JÉWÉ code - EAN code			
			4 kamrás / 4 cham BAL / LEFT	4 kamrás / 4 cham JOBB / RIGHT	6 kamrás / 6 cham BAL / LEFT	6 kamrás / 6 cham JOBB / RIGHT
Bukó-nyíló egyszárnyú ablak One wing window, tilt and turn	58 x 58	1	<b>1102000</b> 5996025058278	<b>1102001</b> 5996025058285	<b>1101000</b> 5996025055369	<b>1101001</b> 5996025055376
	58 x 88	1	<b>1102004</b> 5996025058292	<b>1102005</b> 5996025058308	<b>1101004</b> 5996025056120	<b>1101005</b> 5996025056137
	58 x 118	1	<b>1102008</b> 5996025058315	<b>1102009</b> 5996025058322	<b>1101008</b> 5996025055383	<b>1101009</b> 5996025055390
	88 x 58	1	<b>1102010</b> 5996025058339	<b>1102011</b> 5996025058346	<b>1101010</b> 5996025055406	<b>1101011</b> 5996025055413
	88 x 88	1	<b>1102014</b> 5996025058353	<b>1102015</b> 5996025058360	<b>1101014</b> 5996025055420	<b>1101015</b> 5996025055437
	88 x 118	1	<b>1102018</b> 5996025058377	<b>1102019</b> 5996025058384	<b>1101018</b> 5996025055444	<b>1101019</b> 5996025055451
	88 x 148	1	<b>1102022</b> 5996025058391	<b>1102023</b> 5996025058407	<b>1101022</b> 5996025055468	<b>1101023</b> 5996025055475
	118 x 118	1	<b>1102030</b> 5996025058414	<b>1102031</b> 5996025058421	<b>1101030</b> 5996025055482	<b>1101031</b> 5996025055499
	118 x 148	1	<b>1102034</b> 5996025058438	<b>1102035</b> 5996025058445	<b>1101034</b> 5996025055505	<b>1101035</b> 5996025055511
Bukó-nyíló erkélyajtó Balcony door, tilt and turn	88 x 208	1	<b>1102050</b> 5996025058490	<b>1102051</b> 5996025058506	<b>1101050</b> 5996025055666	<b>1101051</b> 5996025055673
Kétszárnyú ablak, nyíló / bukó-nyíló Two wing window, tilt / tilt and turn	118 x 118	1	<b>1102040</b> 5996025058452		<b>1101040</b> 5996025055628	
	118 x 148	1	<b>1102042</b> 5996025058469		<b>1101042</b> 5996025055635	
	148 x 118	1	<b>1102044</b> 5996025058476		<b>1101044</b> 5996025055642	
	148 x 148	1	<b>1102046</b> 5996025058483		<b>1101046</b> 5996025055659	
Fix felüvilágító ablak Fixed upper window	98 x 30	1	<b>1101060</b> 5996025056144			
Fix oldalvilágító ablak Fixed window	40 x 208	1	<b>1101065</b> 5996025056151			
"Economic" bukó pinceablak "Economic" cellar window	58 x 58	1	<b>1103000</b> 5996025058247			
	78 x 58	1	<b>1103002</b> 5996025058254			
3-kamrás, 60 mm vastag profil, hőszigetelt üvegezés. A kilincs tartozék! 60 mm thick profile with 3 chambers, thermo-isolated glass. Handle for free!"	118 x 58	1	<b>1103005</b> 5996025058261			

## Termékcsoport / Product range

7.04

### Kiegészítő termékek Optional accessories



Ajtó kilincs, fehér  
Door handle, white



Ajtó kilincs, barna  
Door handle, brown



Ajtó kilincs+zárbetét szett fehér  
Door handle+cylinder set white



Ajtó kilincs+zárbetét szett barna  
Door handle+cylinder set brown



Zárbetét, CanDo® ajtóhoz  
Cylinder for CanDo® doors



Ablakkilincs  
Window handle



Beszerező vas  
Metal accessories for installation



PVC takaróléc, fehér, öntapadós  
PVC skirting, white, self adhesive



Soroló profil / PVC profile for matching



Toktoldó profil / Case addition profile



JÉWÉ megnevezés JÉWÉ product name	Méret (cm) Size (cm)	Megrend. egység Order unit	EAN kód EAN code	JÉWÉ kód JÉWÉ code
Ajtó kilincs, fehér Door handle, white		1	4022432521935	<b>1008000</b>
Ajtó kilincs, barna Door handle, brown		1	4022432807107	<b>1008001</b>
Ajtó kilincs+zárbetét szett fehér Door handle+cylinder set white		1	4046722037005	<b>1008012</b>
Ajtó kilincs+zárbetét szett barna Door handle+cylinder set brown		1	4046722037012	<b>1008013</b>
Zárbetét, CanDo® ajtóhoz Cylinder for CanDo® doors	40/50 mm	1	5996025053594	<b>1008020</b>
Ablakkilincs Window handle		1	4022432154676	<b>1107000</b>
Beszerező vas Metal accessories for installation	14 x 2,5	1	5996025056212	<b>1008030</b>
Soroló profil PVC profile for matching	220 x 7	1	5996025056168	<b>1008050</b>
Toktoldó profil Case addition profile	220 x 3	1	5996025056175	<b>1008060</b>
PVC takaróléc, fehér, öntapadós PVC skirting, white, self adhesive	220 x 3 x 0,13	10	5996025059091	<b>1008040</b>
PVC takaróléc, fehér, öntapadós PVC skirting, white, self adhesive	220 x 5 x 0,13	10	5996025059107	<b>1008041</b>

## Termékcsoport / Product range

7.05

CanDo® ablakkönyöklők  
CanDo® windowsills



Fehér ablakkönyöklő  
White windowsill



Aranytölgy ablakkönyöklő  
Golden oak windowsill



Fehér végzáró  
End cap, white



Aranytölgy végzáró  
End cap, golden oak

JÉWÉ megnevezés JÉWÉ product name	Méret (cm) (hossz./szél.) Size (cm) (length/width)	Megrend. egység Order unit	JÉWÉ kód - EAN kód / JÉWÉ code - EAN code	
			FEHÉR WHITE	ARANYTÖLGY GOLDEN OAK
Ablakkönyöklő Windowsill	94 x 20	4	<b>1105000</b> 5996025053884	<b>1105030</b> 5996025055260
Anyaga: kemény PVC Felülete: HPVC (hard polyvinylchlorid). Ellenáll a karcolásnak, víznek és nap- sugárnak Minden ablaktípushoz könnyen beépíthető Bármely beltéri helyiségben alkalmazható	124 x 20	4	<b>1105001</b> 5996025053891	<b>1105031</b> 5996025055277
Material: hard PVC Surface: HPVC (hard polyvinylchlorid) It resists scratching, water and sunbeam It is easy to apply to all window types It can be applied to all interior places	154 x 20	4	<b>1105002</b> 5996025053907	<b>1105032</b> 5996025055284
	94 x 25	4	<b>1105003</b> 5996025053914	<b>1105033</b> 5996025055291
	124 x 25	4	<b>1105004</b> 5996025053921	<b>1105034</b> 5996025055307
	154 x 25	4	<b>1105005</b> 5996025053938	<b>1105035</b> 5996025055314
	94 x 30	4	<b>1105006</b> 5996025053945	<b>1105036</b> 5996025055321
	124 x 30	4	<b>1105007</b> 5996025053952	<b>1105037</b> 5996025055338
	154 x 30	4	<b>1105008</b> 5996025053969	<b>1105038</b> 5996025055345
Ablakkönyöklő végzáró Windowsill end cap	50	10	<b>1105020</b> 5996025054065	<b>1105050</b> 5996025055352

## Termékcsoport / Product range

7.06

### CanDo® beltéri ajtók CanDo® interior doors



Tölgy

Cseresznye

Dió

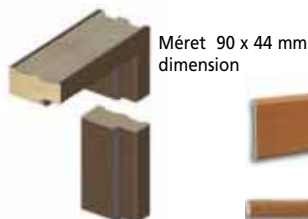



Méret 90 x 44 mm  
dimension



Nida 2

Napoli 4

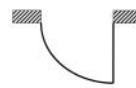
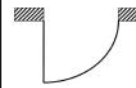
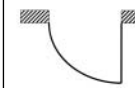
Nida 2

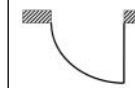
JÉWÉ megnevezés JÉWÉ product name	Méret (cm) (szél./mag.) Size (cm) (width/height)	Megrend. egység Order unit	JÉWÉ kód - EAN kód / JÉWÉ code - EAN code					
			tölgy / oak		cseresznye / cherry		dió / walnut	
			BAL / LEFT	JOBB / RIGHT	BAL / LEFT	JOBB / RIGHT	BAL / LEFT	JOBB / RIGHT
Beltéri ajtólap teli Interior door	75 x 210	1	 <b>1009200</b> 5996025059602	 <b>1009201</b> 5996025059619	 <b>1009300</b> 5996025059800	 <b>1009301</b> 5996025059817	 <b>1009400</b> 5996025059886	 <b>1009401</b> 5996025059893
Beltéri ajtó blokk tok Interior door block frame	75 x 210	1	<b>1009250</b> 5996025059688	<b>1009251</b> 5996025059695	<b>1009350</b> 5996025059824	<b>1009351</b> 5996025059831	<b>1009450</b> 5996025059947	<b>1009451</b> 5996025059954
Beltéri ajtólap teli Interior door	90 x 210	1	<b>1009210</b> 5996025059626	<b>1009211</b> 5996025059633	<b>1009310</b> 5996025060059	<b>1009311</b> 5996025060066	<b>1009410</b> 5996025059909	<b>1009411</b> 5996025059916
Beltéri ajtólap, NIDA 2 üvegezés Interior door, NIDA 2	90 x 210	1	<b>1009215</b> 5996025059664	<b>1009216</b> 5996025059671			<b>1009415</b> 5996025059787	<b>1009416</b> 5996025059794
Beltéri ajtólap, NAPOLI 4 üvegezés / Intrior door, NAPOLI 4	90 x 210	1			<b>1009315</b> 5996025059763	<b>1009316</b> 5996025059770		
Beltéri ajtó blokk tok Interior door block frame	90 x 210	1	<b>1009260</b> 5996025059701	<b>1009261</b> 5996025059718	<b>1009360</b> 5996025059862	<b>1009361</b> 5996025059879	<b>1009460</b> 5996025059848	<b>1009461</b> 5996025059855
Beltéri ajtólap teli Interior door	100 x 210	1	<b>1009220</b> 5996025059640	<b>1009221</b> 5996025059657	<b>1009320</b> 5996025060073	<b>1009321</b> 5996025060080	<b>1009420</b> 5996025059923	<b>1009421</b> 5996025059930
Beltéri ajtó blokk tok Interior door block frame	100 x 210	1	<b>1009270</b> 5996025059725	<b>1009271</b> 5996025059732	<b>1009370</b> 5996025060097	<b>1009371</b> 5996025060103	<b>1009470</b> 5996025060011	<b>1009471</b> 5996025060028
Beltéri ajtó takaróléc szett szögletes Interior door cover set square	6 x 1 x 210	1	<b>1010200</b> 5996025059749		<b>1010300</b> 5996025060110		<b>1010400</b> 5996025060035	
Beltéri ajtó takaróléc szett negyedkör Interior door cover set quadrant	1 x 1,7 x 210	1	<b>1010201</b> 5996025059756		<b>1010301</b> 5996025060120		<b>1010401</b> 5996025060042	
			<ul style="list-style-type: none"> <li>- Méretek: magyar szabvány szerint</li> <li>- MDF blokktok</li> <li>- MDF ajtólap papírrács betéttel</li> <li>- Teljesen síma ajtólap felület</li> <li>- BB zár</li> <li>- Nagyon erős csomagolás</li> <li>- Ajtókilincs nélkül</li> </ul>			<ul style="list-style-type: none"> <li>- Dimensions: according to Hungarian standard</li> <li>- MDF block frame</li> <li>- MDF door leaf with honeycomb insert</li> <li>- Absolutely smooth door leaf surface</li> <li>- standard 72 mm lock</li> <li>- Very strong packaging</li> <li>- Without handle</li> </ul>		

## Termékcsoport / Product range

7.07

Stoppý ajtó-ablak kitámasztó  
Stoppý door and windowstopper

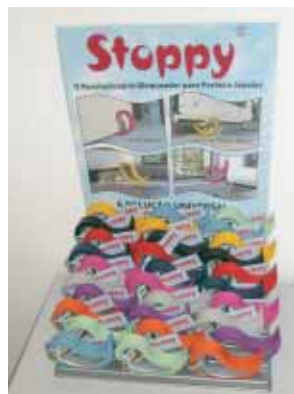

JÉWÉ megnevezés JÉWÉ product name	Szín Color	Megrend. egység Order unit	EAN kód EAN code	JÉWÉ kód JÉWÉ code
Stoppý ajtó-ablak kitámasztó lila Stoppý door and windowstopper violet		5	<b>1107010</b>	4260169240297
Stoppý ajtó-ablak kitámasztó vörös Stoppý door and windowstopper red		5	<b>1107011</b>	4260169240075
Stoppý ajtó-ablak kitámasztó fekete Stoppý door and windowstopper black		5	<b>1107012</b>	4260169240136
Stoppý ajtó-ablak kitámasztó narancs Stoppý door and windowstopper orange		5	<b>1107013</b>	4260169240099
Stoppý ajtó-ablak kitámasztó sárga Stoppý door and windowstopper yellow		5	<b>1107014</b>	4260169240020
Stoppý ajtó-ablak kitámasztó menta Stoppý door and windowstopper mint		5	<b>1107015</b>	4260169240013
Stoppý ajtó-ablak kitámasztó sötétkék Stoppý door and windowstopper navy		5	<b>1107016</b>	4260169240051
Stoppý ajtó-ablak kitámasztó világoskék Stoppý door and windowstopper light Blue		5	<b>1107017</b>	4260169240044
Stoppý ajtó-ablak kitámasztó rózsaszín Stoppý door and windowstopper pink		5	<b>1107018</b>	4260169240037
Stoppý ajtó-ablak kitámasztó áttetsző Stoppý door and windowstopper translucent		5	<b>1107019</b>	4260169240068
Stoppý ajtó-ablak kitámasztó csokoládé Stoppý door and windowstopper chocolate		5	<b>1107020</b>	4260169241775
Stoppý ajtó-ablak kitámasztó lime Stoppý door and windowstopper lime		5	<b>1107021</b>	4260169241140
Stoppý ajtó-ablak kitámasztó fehér Stoppý door and windowstopper white		5	<b>1107022</b>	4260169240082
Stoppý ajtó-ablak kitámasztó olíva Stoppý door and windowstopper petrol		5	<b>1107024</b>	4260169242161
Stoppý vegyes színben Stoppý mixed colours		50	<b>1107030</b>	4260169240303
Stoppý 50 db-os induló csomag (lépcsős) Stoppý 50 pcs starter box (with steps)		1	<b>1107040</b>	
Stoppý 50 db-os induló csomag (kartonos) Stoppý 50 pcs starter box (box)		1	<b>1107050</b>	

## **Magyarország / Hungary**

---

**Horváth Miklós:**

mcex@freemail.hu

+36 30 7012963

(Budapest budai oldala, Baranya, Fejér, Győr-Sopron, Komárom, Pest m. Dunától nyugatra eső területe, Somogy, Tolna, Vas, Veszprém, Zala m.)

**Magyar Lajos:**

lajos.magyar@gmail.com

+36 30 7012964, +36 30 9270056

(Budapest pesti oldala, Bács-Kiskun, Csongrád, Heves, Nógrád, Pest m. Dunától keletre eső része, Szolnok m.)

**Vas József:**

vas.jozsef38@upcmail.hu

+36 30 7012965

(Borsod, Szabolcs, Hajdú-Bihar, Békés m.)

## **Bosznia, Horvátország, Kosovo, Macedónia, Montenegró, Szerbia, Szlovénia, / Bosnia, Croatia, Kosovo, Macedonia, Montenegro, Serbia, Slovenia**

---

**Boris Kremzar:**

boris.kremzar@siol.net

+386 41 429000

## **Románia / Romania**

---

**Aurel Oltean:**

aurel@jewe.hu

+40 723 147482

**Nicu Floroiu:**

nicu\_floroiu@yahoo.com

+40 720 959531

---

# JÉWÉ

JÉWÉ Kereskedelmi Kft.  
H-7673 Kővágószőlős, Golgota hrsz. 502.  
Tel.: (36) 72/564-420 • Fax: (36) 72/564-430  
E-mail: [info@jewe.hu](mailto:info@jewe.hu) • [www.jewe.hu](http://www.jewe.hu)

